

THE UNITED REPUBLIC OF TANZANIA



MINISTRY OF WATER



Dar es Salaam Water supply & Sanitation Authority

DAWASA Building, Dunga/Malaga Street, Mwananyamala Area

P. O. Box 1573, Dar es Salaam. TANZANIA.

Tel. +25522276006/15; Fax: +255222762480; E-mail: dawasaceo@dawasa.co.tz

Comprehensive Project Brief for the Proposed Simplified Sewerage System to be constructed at Kombo Mtaa, Vingunguti Ward, Ilala District, Dar es Salaam Region

Submitted to:

National Environment Management Council,

Head Office, Kambarage Tower, 6th Floor, P. O. Box 2724, Dodoma.

Phone: +255 262960098, 0713608930,

Email Address: nemcdg@nemc.or.tz

Website: www.nemc.or.tz

Lead Consultant:

Prof. Rubhera RAM Mato (PhD), CEng. (T), Reg. EIA Expert

P. O BOX 35478, Dar es Salaam, Tanzania





Mobile: +255754898592; E-Mail: rubheramato@gmail.com

Submission Date: 29th November 2022

ACKNOWLEDGEMENT

The Proponent (DAWASA) wishes to convey a heartfelt thanks and appreciation to all stakeholders who in one way or another supported the completion of this work. Thanks very much all of you. Special thanks to the Ilala Municipal Council Officers for their prompt assistance during the fieldwork. Last but not least we thank the local community and wards leaderships in the project vicinity for their cooperation. A sincere appreciation for all experts and assistants who participated in data collection and preparation of this report.

THE STUDY TEAM

NAME	POSITION	NEMC Reg. No.	SIGNATURE
Prof. Rubhera RAM Mato	Environmental and ESIA Team Leader	Registered NEMC/EIA/0092	
Mr. Robert Kishiki	Sociologist	Not Registered	
Mr. Emmanuel Rajab	Environmental Engineer	Registered EC/EE- EIA/2021/0015	
Mr. Melkizedeck Stephano	Environmentalist	Not Registered	

ABBREVIATIONS

AAQ	Ambient Air Quality
AIDS	Acquired Immuno-Deficiency Syndrome
DAWASA	Dar es Salaam Water Supply and Sanitation Authority
EIA	Environmental Impact Assessment
EMP	Environmental Management Plan
ESIA	Environmental and Social Impact Assessment
ESMP	Environmental and Social Monitoring Plan
GoT	Government of Tanzania
HIV	Human Infection Virus
IDA	International Development Association
LGA	Local Government Authority
NEMC	National Environment Management Council
NEP	National Environment Policy
OGSP	Off-Grid Sanitation Project
PPE	Personal Protective Equipment
PVC	Polyvinyl Chloride
RAP	Resettlement Action Plan
STDS	Sexual Transmitted Diseases

TABLE OF CONTENTS

ACKNOWLEDGEMENT	II
THE STUDY TEAM.....	III
ABBREVIATIONS	IV
EXECUTIVE SUMMARY	VI
1.0 BACKGROUND AND JUSTIFICATION.....	1
1.1 NATURE OF THE PROJECT.....	3
2.0 PROJECT DESCRIPTION	3
2.1 PROJECT LOCATION	3
2.2 ACCESSIBILITY	5
2.3 SPECIFIC FEATURES.....	6
2.4 ADJACENT LAND USE	6
2.5 PROJECT ACTIVITIES.....	7
2.5.1..... MOBILIZATION OR PRE-CONSTRUCTION PHASE	
7	
2.5.2..... CONSTRUCTION PHASE	
7	
2.5.3..... DEMOBILIZATION PHASE	
7	
2.5.4..... OPERATION PHASE	
7	
2.5.5..... DECOMMISSIONING PHASE	
8	
2.6 PROJECT DESIGN.....	8
2.6.1 DESIGN CRITERIA	8
2.6.2. TECHNOLOGY DESCRIPTION	9
2.6.2.1 <i>Layout</i>	9
2.6.2.2 <i>Hydraulics</i>	9
2.6.3. SERVICE CONNECTION	10
2.6.4 DEPTH OF SEWERS.....	10
2.6.5 MANHOLES AND OTHER APPURTENANCES	10
2.6.6 CONSTRUCTION MATERIAL.....	10
2.6.7 TYPICAL SSS HOUSE CONNECTION LAYOUT	11
2.7 UTILITIES	11
3.0 POLICIES, LEGISLATION AND INSTITUTIONAL ARRANGEMENTS	13
3.1 RELEVANT POLICIES.....	13
3.1.1 <i>National Environment Policy 2021</i>.....	13
3.1.2 <i>National Land Policy of 1997</i>	15
3.1.3 <i>Construction Industry Policy (2003)</i>.....	15
3.1.4 <i>National Health Policy (2003)</i>.....	15
3.1.5 <i>National Gender Policy of 2000</i>	16

3.1.6 <i>National Human Settlements Development Policy (2000)</i>	16
3.2 PRINCIPAL LEGISLATIONS AND REGULATIONS	16
3.2.1 <i>Environmental Management Act (2004)</i>	16
3.2.2 <i>The Environmental Management (Fees and Charges) Regulations, 2021</i>	17
3.2.3 <i>The Environmental Management (Control of hazardous Waste)</i> <i>regulations, 2021</i>	18
3.2.4 <i>The Environmental Management (Control of Noise and vibration)</i> <i>regulations, 2015</i>	18
3.2.5 <i>The Environmental Management (Prohibition of Plastic Carrier bags)</i> <i>regulations, 2019</i>	19
3.2.6 <i>The Environmental Management (Solid Waste Management) regulations,</i> <i>2007</i>	19
3.2.7 <i>The Environmental Management (Water Quality) regulations, 2009</i>	20
3.2.8 <i>The Environmental Management (Air Quality) regulations, 2009</i>	20
3.2.9 <i>The Environmental Management (Soil Quality) regulations, 2009</i>	21
3.2.10 <i>Occupational Health and Safety Act 2003</i>	21
3.2.11 <i>The Water Supply and Sanitation Act No. 12 of 2009</i>	22
3.12 <i>Engineers Registration Act and its Amendments 1997 and 2007</i>	22
3.2.13 <i>The Contractors Registration (Amendment) Act, 2008</i>	22
3.2.14 <i>The Architects and Quantity Surveyors Act (1997)</i>	23
3.2.15 <i>The Urban Planning Act (2007)</i>	23
3.2.16 <i>Public Health Act (2009)</i>	23
4.1 INTRODUCTION	24
4.2 PHYSICAL CHARACTERISTICS	25
4.2.1 <i>Climate</i>	25
4.2.2 <i>Soils, Geology and Hydrogeology of the area</i>	26
4.2.3 <i>Topography</i>	27
4.2.4 <i>Air Quality and Noise Level</i>	27
4.2.5 <i>Noise and Vibration</i>	27
4.3 BIOLOGICAL CHARACTERISTICS	27
4.3.1 <i>Flora and Fauna</i>	27
4.4 SOCIO-ECONOMIC SET-UP	28
4.4.1 <i>Administrative boundaries</i>	28
4.4.2 <i>Demographic characteristics</i>	28
4.4.3 <i>Economic Activities</i>	30
4.4.4 <i>Education</i>	31
4.4.5 <i>Economic infrastructures</i>	32
4.4.6 <i>Social Services Infrastructure</i>	33
4.4.7 <i>Solid Waste management</i>	34
4.4.8 <i>Waste Collection and Transportation</i>	37
4.4.9 <i>Housing</i>	37
5.0 PROJECT REQUIREMENTS AND WASTE GENERATION	38
5.1 PROJECT REQUIREMENTS	38
5.1.1 <i>Construction materials and labour force</i>	38
5.1.2 <i>Labour force</i>	38
5.1.3 <i>Machinery and Equipment</i>	38
5.2 WASTES GENERATION	38
5.2.1 <i>Liquid waste management</i>	38

5.2.2	<i>Solid waste management</i>	39
6.0	POTENTIAL IMPACTS	40
6.1	POSITIVE IMPACTS.....	40
6.1.1	<i>Improved living conditions and economic growth</i>	40
6.1.2	<i>Employment opportunities</i>	40
6.1.3	<i>Increased socio-cultural interaction</i>	40
6.1.4	<i>Increased Revenue to the nation through taxes, both direct and indirect</i>	40
6.1.5	<i>Cost reduction for sewage management</i>	41
6.2	NEGATIVE IMPACTS	41
6.2.1	<i>Increased HIV/AIDS and other sexual related diseases:</i>	41
6.2.2	<i>Land degradation and increased erosion</i>	42
6.2.3	<i>Noise pollution</i>	42
6.2.4	<i>Air Pollution from dust emission</i>	42
6.2.5	<i>High Risk of Health associated with construction work</i>	43
6.2.6	<i>Waste generation during construction</i>	43
7.0	ACTION PLAN FOR PREVENTION AND MANAGEMENT OF ACCIDENTS DURING IMPLEMENTATION STAGE	44
7.1	HEALTH AND SAFETY	44
7.2	SECURITY	44
7.3	MONITORING, MAINTENANCE AND REPAIR	45
8.0	ENVIRONMENTAL AND SOCIAL MANAGEMENT PLAN	45
8.1	ENVIRONMENTAL AND SOCIAL MANAGEMENT PLAN	45
9.0	MONITORING PLAN	56
9.1	ENVIRONMENTAL MONITORING.....	56
10.0	PROJECT BUDGET	61
11.0	STAKEHOLDER VIEWS ON THE PROPOSED PROJECT	61
12.0	CONCLUSION AND RECOMMENDATION	63
	REFERENCES	64
	APPENDIX I: LIST OF STAKEHOLDERS CONSULTED	65
	APPENDIX II: MINUTES OF MEETINGS WITH LOCALS	68
	APPENDIX III: SCREENING DECISION FROM NEMC	76
	APPENDIX IV: MEMORANDUM OF UNDERSTANDING BETWEEN DAWASA AND DAR ES SALAAM MUNICIPAL COUNCILS	78
	APPENDIX V: LETTER FROM ILALA MUNICIPAL SHOWING THE PERMIT TO USE THE AREA FOR THE PROJECT	79
	APPENDIX VI: APPROVED ARCHITECTURAL DRAWINGS	80
	APPENDIX VII: NON-TECHNICAL SUMMARY	81

LIST OF FIGURES

Figure 1: A Map of Dar es salaam region showing the project Municipal.....	4
Figure 2: An Extract Google view to show the Location of the project area	5
Figure 3: Some vegetation and commercial building structures at the project area	6
Figure 4: Power lines, railway line and Industrial complexes close to the project site	6
Figure 5: Typical Simplified Sewerage system layout aerial view	12
Figure 6: Stakeholder’s consultation meeting at Ilala Municipal office and Vingunguti community.....	61

LIST OF TABLES

Table 1: Management of construction and operation wastes	39
Table 2: Environmental and Social Management Plan for the Proposed Construction of Simplified sewerage system at Kombo street, Vingunguti Ward, Ilala Municipal	47
Table 3: Monitoring Plan for the Proposed Construction of Simplified sewerage system at Kombo street, Vingunguti Ward, Ilala Municipal	57
Table 4: Stakeholders issues and concerns	62

EXECUTIVE SUMMARY

Comprehensive Project Brief for the Proposed Simplified Sewerage System to be constructed at Kombo Mtaa, Vingunguti Ward, Ilala District, Dar es Salaam Region

Proponent: DAWASA

Proponent's Contact: DAWASA House, **Dunga/Malanga**

Street/Mwananyamala

P.O Box 1573 DSM

Tel: +255222760006/15

Fax: +255222762480

Email Address: info@dawasa.go.tz

EIA Expert: **Prof. Rubhera RAM Mato**

(PhD), CEng. (T), Reg. EIA Expert

Mobile: +255754898592

E-Mail: rubheramato@gmail.com

INTRODUCTION

The Government of the United Republic of Tanzania (GoT) through the Dar es Salaam Water and Sewerage Authority (DAWASA) under the Ministry of Water intends to implement an Off-Grid Sanitation Project (OGSP) in Dar es Salaam City to serve peri-urban areas not connected to the central sewerage system. DAWASA has received financing from the International Development Association (IDA) in the form of a credit to implement the project. Before implementing the project, the law in Tanzania requires an Environmental Impact Assessment to be conducted and approved by the relevant authority. To comply with the law in Tanzania, the DAWASA intends to apply a portion of the proceeds of the credit to eligible payments for consulting services for Preparation of Environmental and Social Impact Assessment (ESIA) and Resettlement Action Plan (RAP) Report for the construction of off-grid sanitation projects.

Dar es Salaam is the largest and most important commercial and industrial center in Tanzania. The city has an estimated population of about 5.0 million and is projected to double at the end of the project horizon of 25 years. About 10% of the population is served by sewers and the rest almost depend on on-site sanitation systems. The sewer coverage is only limited to the area within the city center with a total length of 67.8km and the system is based on a separate system and discharges their effluent into oxidation ponds, and into the sea through a sea outfall of about 1.03km long. The onsite sanitation systems result in Faecal sludge of which handling and management throughout the sanitation chain (from domestic containment, transportation as well as disposal and treatment) is currently hygienically inadequate thus posing environmental and public health risks. The Off-Grid project is intended to address these challenges. The Off-Grid project is divided into several subprojects which will be implemented in the five municipalities of Dar es Salaam City. One of these is the Construction of Simplified Sewerage System at Kombo Mtaa, in Vingunguti Ward, Ilala District. The project is planned to connect 570 households with an estimated population of 25,600 people.

This study was conducted following the Environmental Management (Environmental Impact Assessment and Audit) (Amendment) Regulations, 2018 along with the Environmental Impact Assessment and Audit Regulations of 2005. These Regulations provide legal procedures for implementing the requirements of the Environmental Management Act Cap.191 of 2004. The Regulations give a mandate to NEMC to oversee the EIA process, which culminates with an award of the EIA Certificate by the Ministry responsible for Environment.

Following the EIA Regulations, NEMC is mandated to screen projects and make decisions of the level of EIA required as well as evaluating the adequacy of respective environmental statements. Considering the nature and size of the proposed “Simplified Sewerage System in Ilala Municipality”, the project falls under Category “B2” (Non-Mandatory) following Reg.4 (1)(c) and First Schedule of the amended 2018 Regulations which categorizes the *night soil collection and*

treatment being under the 'List of small-scale activities and enterprises that require registration but shall not require Environmental Impact Assessment. Further, the projects shall not require screening and scoping, rather, the Project Brief shall be examined and issued with an Environmental Impact Assessment Certificate'. The regulations require developers to prepare and submit to the National Management Council (NEMC) filled EIA registration forms and "Project Briefs" for all B2 projects. The preparation and content of the "Project Briefs" are provided under Reg.6 (1). The same has been followed in preparing this "Project Brief". The study for preparing this project brief was conducted from July to October 2020.

This project brief for the Proposed Construction of Simplified Sewerage System in Ilala Municipality is being submitted to NEMC together with EIA Registration Forms for EIA Certificate decision.

PROJECT DESCRIPTION

Vingunguti is an administrative ward situated at -6.840225 Longitude, 39.23411 Latitude in Ilala District of Dar-es-salaam Region. The ward that is located in the southwest of Dar-es-salaam, comprises of six streets that is Mtambani, Mtakuja, Miembeni, Kombo, Butiama and Majengo. The streets are unplanned settlement with restricted access roads for fecal sludge emptying trucks. Furthermore, the ward is characterized by having underlying geographical formation setback where water table is significantly high.

Currently, this area is being served through on-site sanitation management that involves domestic containment and emptying trucks that are not satisfactorily managed.

The project area is accessible through Nkurumah street then Julius Nyerere road all the way to Nelson Mandela junction finally unto Mandela road at Sheli bus stop 8.4 Kilometers.

The proposed project intends to use the existing alleys (*vichocho*) for installing the simplified sewer pipelines. The local government in the project area has agreed with DAWASA through a formal meeting held on 09/07/2020 to use the alleys whether formal or non-formal for the construction of a simplified sewerage system and the associated appurtenances to improve the sanitation conditions.

POLICIES, LEGISLATION AND INSTITUTIONAL ARRANGEMENTS

Sector policies that were reviewed when executing the proposed development are;

- National Environment Policy 2021
- National Land Policy of 1997
- Construction Industry Policy (2003)
- National Health Policy (2003)
- National Gender Policy of 2000
- National Human Settlements Development Policy (2000)

Principal Acts, regulations and guidance that support and provide guidelines to implement the intended project are;

- Environmental Management Act (2004)
- The Environmental Management (Fees and Charges) Regulations, 2021
- The Environmental Management (Control of hazardous Waste) regulations, 2021
- The Environmental Management (Control of Noise and vibration) regulations, 2015
- The Environmental Management (Prohibition of Plastic Carrier bags) regulations, 2019
- The Environmental Management (Solid Waste Management) regulations, 2007
- The Environmental Management (Water Quality) regulations, 2009

- The Environmental Management (Air Quality) regulations, 2009
- The Environmental Management (Soil Quality) regulations, 2009
- Occupational Health and Safety Act 2003
- The Water Supply and Sanitation Act No. 12 of 2009
- Engineers Registration Act and its Amendments 1997 and 2007
- The Contractors Registration (Amendment) Act, 2008
- The Architects and Quantity Surveyors Act (1997)
- The Urban World Bank guidelines for Environmental Management and Planning Act (2007)
- Public Health Act (2009)

STAKEHOLDERS ISSUES AND CONCERNS

Different stakeholders were consulted. Among of the issues that arise during consultation at the Ilala Municipal Council and community at Kombo Mtaa are:

Facilities to be developed

- Proper awareness to people on best ways to dispose pads and other waste in order to avoid system blockage
- The proposed facilities should be well protected

Awareness to the community

- Awareness to the people on the system operation, since it is a new technology
- Awareness to the community to avoid riots in the future
- Educate the community to avoid the use of detrimental disinfectants to the system so as to avoid system failure and contaminated manures.

PROJECT REQUIREMENTS AND WASTE GENERATION

Project requirements

The main materials for construction of Simplified sewerage system include cement, aggregates (stones), water, steel, sand, timbers, blocks, PVC pipes,

and gravels. During the construction phase the project will require not less than 100 workers both skilled and non-skilled laborers for each phase of project construction. During operational phase it is estimated that 30 unskilled workers will be retained for operating the system.

Equipment expected to be used during the construction works are Tippers, Concrete Mixers, poker vibrators, Wheel barrow, Compactor, etc.

Wastes generation

The major wastes generation associated with the project are solid wastes and liquid waste. During the maximum operation phase a total of 100m³ per day of liquid waste is estimated to be received at the downstream receiving chamber of the Fecal sludge treatment facility close to the project site. During construction it is expected that at least 60kg of solid wastes will be produced.

POTENTIAL IMPACTS

The following impacts were identified to be likely to occur during mobilization phase:

- Employment opportunities
- Noise pollution
- Air pollution from dust emission
- Blockage of paths

The following impacts were identified to be likely to occur during the construction phase;

- Employment opportunities
- Increased socio-cultural interaction
- Increased Revenue to the nation through taxes, both direct and indirect
- Cost reduction for sewage management
- Increased HIV/AIDS and other sexual related diseases
- Land degradation and increased erosion
- Noise pollution

- Air Pollution from dust emission
- High Risk of Health associated with construction work
- Waste generation during construction
- Sewer leakage/overflow
- Blockage of paths

The following impacts were identified to be likely to occur during the operational phase;

- Improved social-economic livelihood and dignity within the beneficiary society
- Increased Revenue to the nation through taxes, both direct and indirect
- Cost reduction for sewage management
- Sewer leakage/overflow

MITIGATION MEASURES AND ENVIRONMENTAL AND SOCIAL MANAGEMENT PLAN (ESMP)

The options to minimize or prevent the identified adverse social and environmental impacts as well as a monitoring plan have been suggested in this report and are contained in the ESMP. Many of them are based on good engineering practices and the timely responsiveness of the responsible institution. The ESMP describes the implementation schedule of the proposed mitigation measures as well as planning for long-term monitoring activities. It defines the roles and responsibilities of different actors of the plan. The Approach environmental and social costs amount to Tshs 38,000,000.00. The estimated annual costs for carrying out the proposed environmental and social motoring program amounts to TSH 28,000,000.00.

DECOMMISSIONING PLAN

The decommissioning is not anticipated in the foreseeable future. However, if this will happen, may entail change of use (functional changes) or demolition triggered by change of land use. In view of this, specific mitigation measures pertaining to

environmental impacts of decommissioning works cannot be proposed at the moment with a reasonable degree of certainty.

CONCLUSION

The proposed project is of greater profit to the community and the country at large as it promotes and improve sanitation in the streets. When there is good and improved sanitation, then the outbreak of diseases like diarrhoea and associated stomach and waterborne diseases are also reduced and prevented hence improved public health.

The impacts identified are preventable and of less negativity to the community, therefore the developer can be provided with the environmental clearance certifacte in order to commence the implimentation of the project.

It is, therefore, concluded that implementation of the proposed construction of the Simplified sewerage system at Kombo Mtaa will entail no detrimental impacts provided that the recommended mitigation measures are adequately and timely put in place. The identified adverse impacts shall be managed through the proposed mitigation measures and implementation regime laid down in this EIS. DAWASA is committed to implementing all the recommendations given in the EIS and further carrying out the environmental auditing and monitoring schedules.

Comprehensive Project Brief for the Proposed Simplified Sewerage System to be constructed at Kombo Mtaa, Vingunguti Ward, Ilala District, Dar es Salaam Region

1.0 BACKGROUND AND JUSTIFICATION

The Government of the United Republic of Tanzania (GoT) through the Dar es Salaam Water supply and Sanitation Authority (DAWASA) under the Ministry of Water intends to implement an Off Grid Sanitation Project (OGSP) in Dar es Salaam City to serve peri-urban areas not connected to the central sewerage system. DAWASA has received financing from the International Development Association (IDA) in the form of a credit to implement the project. Prior to the implementation of the project, the law in Tanzania requires an Environmental Impact Assessment to be conducted and approved by relevant authority. In order to comply with the law in Tanzania, the DAWASA intends to apply a portion of the proceeds of the credit to eligible payments for consulting services for Preparation of Environmental and Social Impact Assessment (ESIA) and Resettlement Action Plan (RAP) Report for construction of off grid sanitation projects.

Dar es Salaam is the largest and most important commercial and industrial center in Tanzania. The city has an estimated population of about 5.0 million and is projected to double at the end of the project horizon of 25 years (ToR). About 10% of the population is served by sewers and the rest almost depend on on-site sanitation systems. The sewer coverage is only limited to the area within city center with a total length of 67.8km and the system is based on a separate and discharge their effluent into oxidation ponds, and into the sea through sea outfall of about 1.03km long. The onsite sanitation systems result into Faecal sludge of which handling and management throughout the sanitation chain (from domestic containment, transportation as well as disposal and treatment) is currently hygienically inadequate thus posing environmental and public health risks. The Off-Grid project is intended to address these challenges. The Off-Grid project is divided into several subprojects which will be implemented in the five municipalities of Dar es Salaam City. One of these

is the Construction of Simplified Sewerage System at Kombo street, in Vingunguti Ward, Ilala Municipality. The project is planned to connect 570 households with an estimated population of 25,600 people.

This study is conducted in accordance with the Environmental Management (Environmental Impact Assessment and Audit) (Amendment) Regulations, 2018 along with the Environmental Impact Assessment and Audit Regulations of 2005. These Regulations provide legal procedures for implementing the requirements of the Environmental Management Act Cap.191 of 2004. The Regulations give mandate to NEMC to oversee the EIA process, which culminates with an award of the EIA Certificate by the Ministry responsible for Environment.

In accordance with the EIA Regulations, NEMC is mandated to screen projects and make decisions of level of EIA required as well as evaluating the adequacy of respective environmental statements. Considering the nature and size of the proposed “Simplified Sewerage System in Ilala Municipality”, the project falls under Category “B2” (Non-Mandatory) in accordance with Reg.4 (1)(c) and First Schedule of the amended 2018 Regulations.

The regulations require developers to prepare and submit to the National Management Council (NEMC) filled EIA registration forms and “Project Briefs” for all category B2 projects. The preparation and content of the “Project Briefs” is provided under Regulation 6(1) of Environmental Impact Assessment and Audit Regulations, 2005. The same has been followed in preparing this “Project Brief”. The study for preparing this project brief was conducted from July to October 2020.

This project brief for the Proposed Construction of Simplified Sewerage System in Ilala Municipality is being submitted to NEMC together with EIA Registration Forms for EIA Certificate decision.

1.1 NATURE OF THE PROJECT

The proposed project concerns construction of Simplified sewerage system for public use at Kombo street, Vingunguti Ward, Ilala District. The nature of the project enhances environmental protection through proper handling and disposal of domestic sewage. According to First Schedule of the EIA and Audit Regulations (Amended) of 2018, the nature of the project is small and entails no significant impacts. The project can be categorised as Type B2, which according to the regulations are “small-scale activities and enterprises that require registration but shall not require Environmental Impact Assessment. Further, the projects shall not require screening and scoping, rather, the Project Brief shall be examined and issued with an Environmental Impact Assessment Certificate”.

2.0 PROJECT DESCRIPTION

2.1 Project Location

Vingunguti is an administrative ward situated at -6.840225 Longitude, 39.23411 Latitude in Ilala District of Dar-es-salaam Region. The ward that is located in the southwest of Dar-es-salaam, comprises of six streets that is Mtambani, Mtakuja, Miembeni, Kombo, Butiama and Majengo. The streets are unplanned settlement with restricted access roads for faecal sludge emptying trucks. Furthermore, the ward is characterized by having underlying geographical formation setback where water table is significantly high.

Depending on nature of the environment, the area is being served through on site sanitation management that involve domestic containment and emptying trucks that are not satisfactory managed. Apart from illegal emptying, underground seepage of faecal sludge may also contaminate ground water leading to water related diseases within this area. To address above challenges, we recommend construction of simplified sewerage system as the solution of faecal sludge management within the area. Depending on the size of proposed areas for project implementation this project will be implemented in two Lots at Kombo street i.e. Kombo Lot I and Kombo Lot II, figure 1.

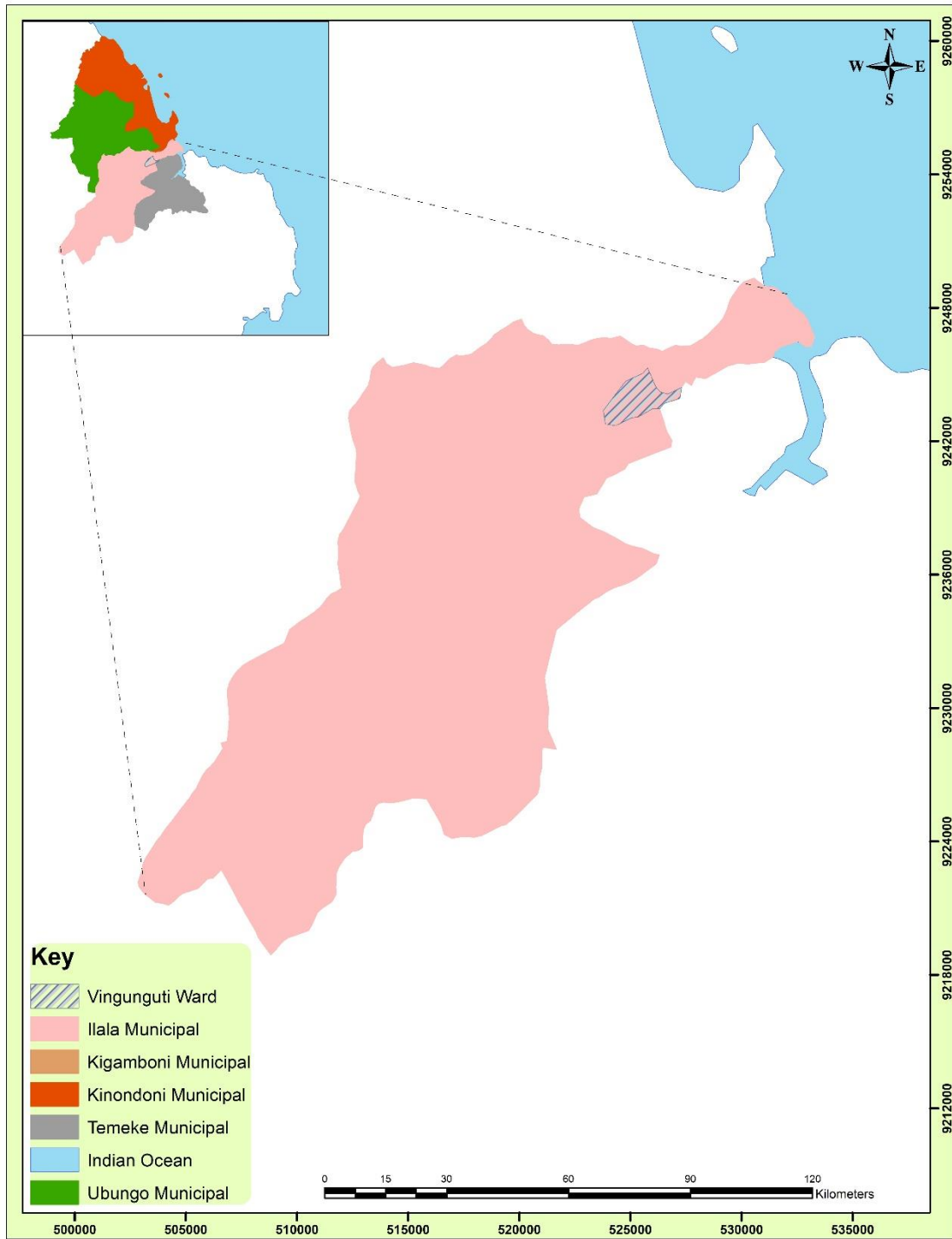

Figure 1: A Map of Dar es salaam region showing the project Municipal

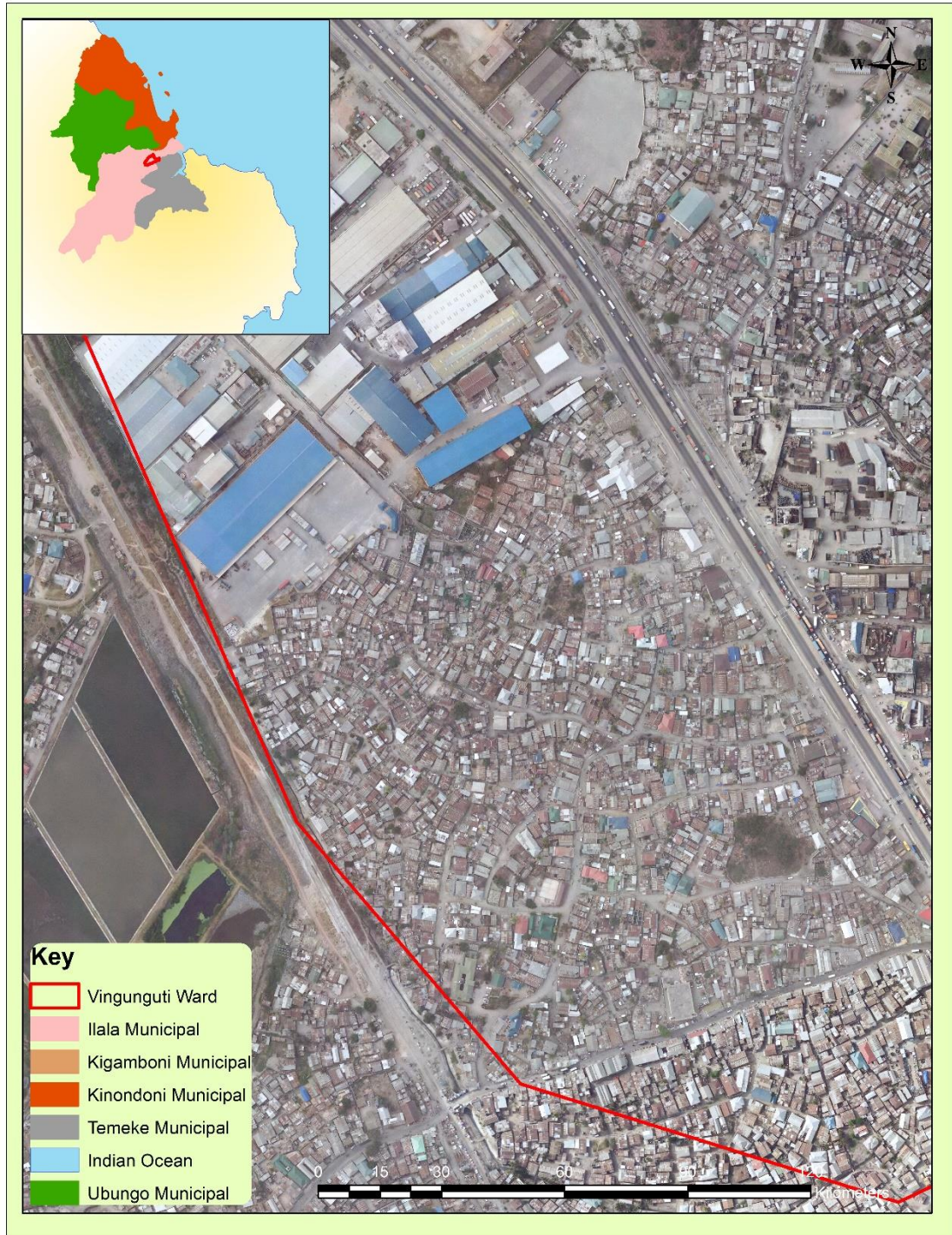

Figure 2: An Extract Google view to show the Location of the project area

2.2 Accessibility

The project area is accessible through Nkurumah street then Julius Nyerere road all the way to Nelson Mandela junction finally unto Mandela road at Sheli bus stop 8.4 Kilometers.

2.3 Specific Features

The proposed project site is characterized with a few vegetation, residential and commercial buildings as were observed afar from the project site, Figure 3.



Figure 3: Some vegetation and residential building structures at the project area

2.4 Adjacent Land Use

The project site is surrounded by residential buildings, power lines, waste water stabilization ponds, parking lots, railway line and Industrial complexes, Figure 4.



Figure 4: Power lines, railway line and Industrial complexes close to the project site

2.5 PROJECT ACTIVITIES

2.5.1 Mobilization or pre-construction phase

This phase entails mobilization of labour force, and equipment as well as acquisition of various permits as required by the law.

Other activities during this phase include;

- Topographical Survey for setting out purposes,
- Construction Materials' source Investigation,
- Material transportation, storage and material preparation,

2.5.2 Construction phase

This phase entails all the necessary installations, site grading and placement of the facility components. The major activities include;

- Trench excavation and laying of 4" and 6" PVC pipes for collection of wastewater from households.
- Backfilling and paving of excavated trenches
- Construction of inspection chambers/junction boxes
- Construction of receiving chambers
- Connection of customers' latrines to the constructed network

2.5.3 Demobilization phase

This phase will involve the dismantling of temporary structures such as scar fording and removing/spreading spoil materials for proper restoration of the site.

Other activities include;

- General cleanliness of the area, that is clearance of all sorts of solid wastes (plastics, wood, metal, papers, etc);
- Deposit all wastes to the authorized dumpsite;

2.5.4 Operation phase

The phase entails the actual usage of the Simplified sewerage system where as the individual household will be discharging night soil directly to the system. The main task will be occasional clearance of the blockages and timely

replacement of leaking pipes undertaken by DAWASA with the sole cooperation from household owners at the vicinity.

2.5.5 Decommissioning Phase

Decommissioning is not anticipated in the foreseeable future as the completed facility will be serving a number of houses which at present incur many costs to dispose fecal sludge and if not so tend to discharge illegally. However, if this will happen, may entail change of use (functional changes) or demolition triggered by change of land use.

2.6 PROJECT DESIGN

Kombo Simplified sewerage system will involve construction of a simplified sewerage network discharging wastewater into existing sewer line to Vingunguti wastewater stabilization ponds. The system is planned to collect wastewater from surrounding households using 4" PVC pipes laid in shallow depth trenches. The system will operate under controlled gravity flow in accordance to designed gravity and velocity. Collected sewerage will be injected into the existing sewerage conveyance pipe and eventually discharged at the existing Vingunguti wastewater stabilization ponds. The existing water ponds have the capacity of around 1849 cubic meters per day.

2.6.1 Design criteria

Conceptually, simplified sewerage is the same as Conventional Gravity Sewerage, but without unnecessarily conservative design standards and with design features that are better adapted to the local situation. The pipes are usually laid within the property boundaries, through either the back or front yards, rather than beneath the central road, allowing for fewer and shorter pipes.

Some of the criteria and standards for the design of the sewers are:

- Minimum velocity in pipe
- Minimum slopes of pipes

- Minimum pipe diameter
- Design peak flow factor

2.6.2. Technology description

2.6.2.1 Layout

To avoid deep excavations, long trunk pipes to interceptors, and large pumping stations, serious consideration is given to splitting the network into two or more smaller systems. Although network layout is also an important part of conventional design, the optimization of pipe lengths and network subdivisions takes on even greater importance in this system.

2.6.2.2 Hydraulics

Design period

Another approach to sewerage systems that can bring major benefits to the project is to reduce the design period of the sewerage system. A great advantage of using shorter term periods is that it avoids uncertainties of population growth and reduces the high costs of maintenance of large sewer systems with low flow. Other benefits of the reduced design period, are that it can also facilitate financing and achieve greater coverage with the same investment.

Design flow

Wastewater flow quantities are necessarily lower than the quantity of water supplied because water is lost through leakage, garden watering, house cleaning, etc. To determine the expected amount of wastewater, it is important to keep records of pumpage for each day and fluctuations during the day.

Where water use information is not available, the simplified sewerage system is - designed for a minimum flow of 1.5 l/s, infiltration is assumed to be 0.05-1.0 l/s/km of pipe.

2.6.3. Service Connection

In the simplified design, a 60-cm connection (or inspection) box is placed between the building and the service line. All the sewers or drains from the house or building enter the box. This box is usually located under the sidewalk in the public right of way

2.6.4 Depth of sewers

For any type of sewer connection, it is standard to have a minimum depth in which the pipes are laid should be sufficient to make house connections and have a layer of soil over the crown to protect the pipe against structural damage from external loads and frost. On simplified connections, the minimum sewer depths are usually much shallower than the conventional systems. Being as shallow as 0.65-m below sidewalks, 0.95-1.50-m below residential streets (depending on distance from the centerline of street), and 2.5-m below heavily traveled streets.

2.6.5 Manholes and other appurtenances

One of the most important differences between conventional and simplified sewer systems is that the former utilizes many manholes, whereas the latter type avoids its use as much as possible. The conservative criteria for manhole use contributes to the high cost of sewerage. The use of shallower depths is one way of reducing these costs.

In conventional systems, manholes are generally located at:

- The upper ends of all laterals
- Changes in direction and slope
- Pipe junctions, except building connections
- At intervals not greater than 100m for pipes up to 600mm diameter

2.6.6 Construction Material

The types of materials used in SSS are similar to those used in conventional sewers. The most commonly used and readily available in the market are

polyvinyl chloride (PVC) pipes. Additionally, PVC pipes offer the advantage of longer sizes, fewer joints (i.e. less infiltration), light weight, water tightness and uniformity. All these materials will be stored in the contractors site office/camp which will be built prior to project

2.6.7 Typical SSS house connection layout

The proposed construction of simplified sewerage system will have the similar appearance as the typical layout shown in figure 5.

2.7 Utilities

Water

The main source of water for all project phases is expected to be DAWASA.

Power supply

Power will be supplied from TANESCO whenever necessary,

Manpower.

The project is expected to provided employment to about 100 people directly and indirectly for both skilled and unskilled labors.

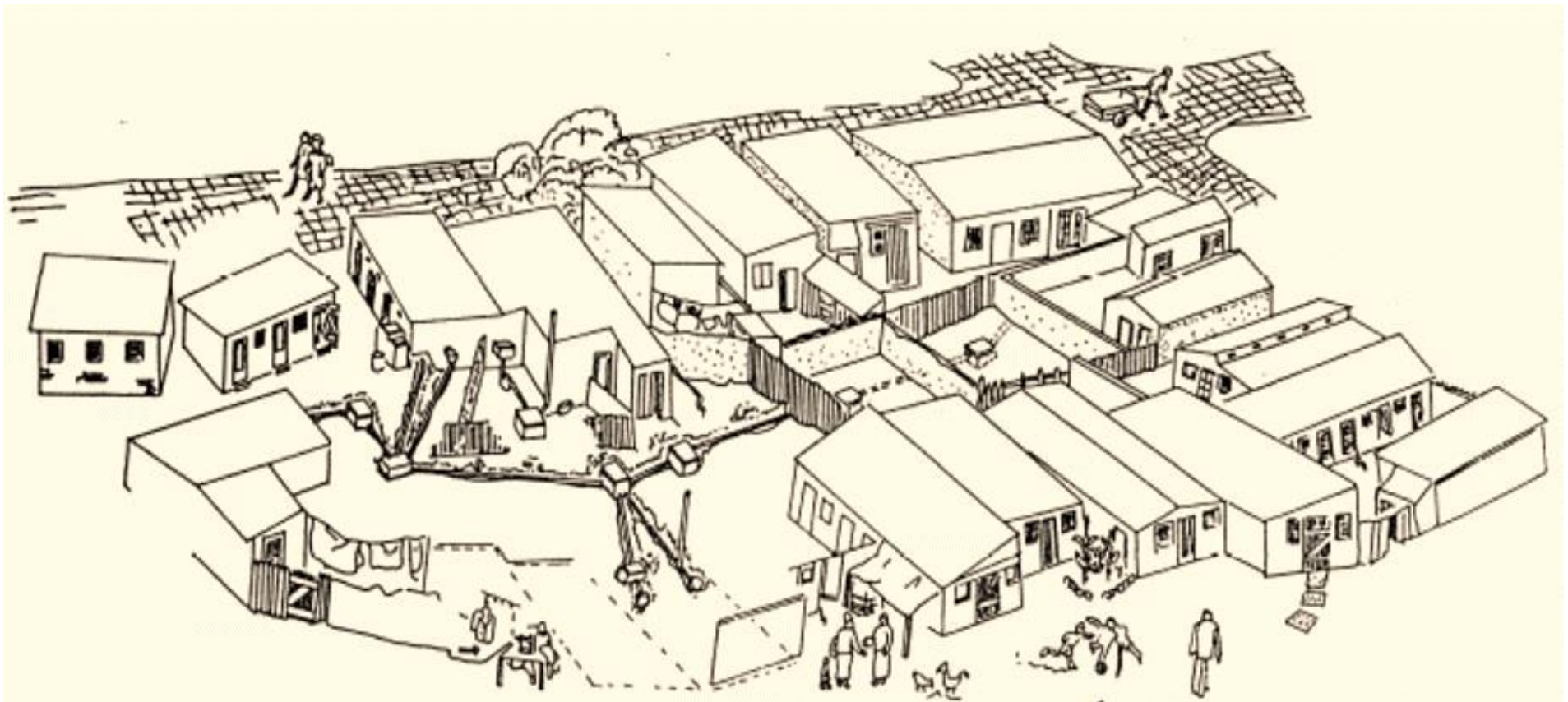

Figure 5: Typical Simplified Sewerage system layout aerial view

3.0 POLICIES, LEGISLATION AND INSTITUTIONAL ARRANGEMENTS

According to the fundamental principles of environment, any developmental activities of this nature such as construction of simplified Sewerage System would have socio-economic and somehow environmental impacts that must be addressed and governed in order to serve public interest and sustainable development. Given the many existing and developing environmental laws, regulations and standards in Tanzania, it is worth considering resorting to constitutional provisions to protect and manage the environment. With increasing environmental awareness in recent decades, the environment has become a higher political priority and many constitutions now expressly guarantee a 'right to a healthy environment', as well as the procedural rights necessary to implement and enforce the substantive rights granted. The public or national interest in this aspect is addressed through government Policies and regulated by Principal Acts and Regulations. The implementation of the proposed project shall touch various sectors; therefore, the developer has to comply with number of cross-sectorial policies and legislations relevant to this project. Also, the listed institutions involved in environmental management for the project is included in this chapter.

3.1 RELEVANT POLICIES

This section focuses on various policies which guide the development aspects for sustainable vision, apart from the national environmental policy, there are numbers of sector policies that are to be reviewed when executing the proposed development and these include;

3.1.1 National Environment Policy 2021

The National Environmental Policy of 2021 has just been launched in February 2021. The new policy formulation is a revision of the National Environmental Policy of 1997. The Policy serves as a national framework for planning and sustainable management of the environment in a coordinated, holistic and adaptive approach taking into consideration the prevailing and emerging environmental challenges as well as national and international development

issues. Effective implementation of this policy requires mainstreaming of environmental issues at all levels, strengthening institutional governance, and public participation in environmental management regimes. The long-term vision of this policy is geared towards the realization of environmental integrity, assurance of food security, poverty alleviation, and increased contribution of the environmental resources to the national economy. It also recommends strong institutional and governance measures to support the achievement of the desired objectives and goals.

The policy seeks to promote the economy and livelihoods of people while promoting sustainable utilization of natural resources in the country. The policy provides the framework for the formulation of plans, programmes, and guidelines for the achievement of sustainable development.

The policy overall objective is to provide a national framework for guiding harmonized and coordinated environmental management for the improvement of the welfare of present and future generations. The specific objectives are i) to strengthen coordination of environmental management in sectors at all levels; ii) to enhance environmentally sound management of land resources for socioeconomic development; iii) to promote environmental management of water sources; iv) to strengthen conservation of wildlife habitats and biodiversity; v) to enhance conservation of forest ecosystems for sustainable provision of environmental goods and services; vi) to manage pollution for the safe and healthy environment; vii) to strengthen the national capacity for addressing climate change impacts; viii) to enhance conservation of aquatic system for the sustained natural ecosystem; ix) to ensure safety at all levels of application of modern biotechnology; x) to promote gender consideration in environmental management; xi) to promote good governance in environmental management at all levels; and xii) to ensure predictable, accessible, adequate and sustainable financial resources for environmental management.

3.1.2 National Land Policy of 1997

The National Land Policy states that “the overall aim of a National Land Policy is to promote and ensure a secure land tenure system, to encourage the optimal use of land resources, and to facilitate broad-based social and economic development without upsetting or endangering the ecological balance of the environment”. This study partly responds to this requirement.

3.1.3 Construction Industry Policy (2003)

Among the major objectives of the policy, which supports a sustainable building development sector, include the promotion and application of cost effective and innovative technologies and practices to support socio-economic development activities such as sanitation, water supply, buildings, road-works, shelter delivery and income generating activities and to ensure application of practices, technologies and products which are not harmful to either the environment or human health. Proposed project is in-line with this policy as ultra-modern technology is used during construction and its operation.

3.1.4 National Health Policy (2003)

The Health Policy is a vital guide towards health development of any country. It is particularly, important in a country like ours where resources and technology are more limited than in other countries, which are relatively better off in both technology and resources. This Policy is a revision of the 1990 Health Policy, which emphasized on the need for increasing community involvement in health development and improved access and equity in health and health services.

The Policy recognizes the challenges of consolidating the principles of the previous health policy in community involvement, improved health services provision, access and equity while addressing the different dimensions of reforms that are taking place in the Public Sector.

The proposed project will adhere to policy requirements to ensure no transmission of such communicable diseases between construction workers and the community, protect workers from all sorts of health risks and hazards;

and provide adequate sanitation services within the project and ensure that its activities are not a source of health issues.

3.1.5 National Gender Policy of 2000

The overall objective of the Gender and Development Policy is to promote gender equality and equal participation of men and women through facilitation of access to education, child care, and employment and decision making. Also this policy is to provide guidelines that will ensure that gender-sensitive plans and strategies are developed in all sectors and institutions. While the policy aims at establishing strategies to eradicate poverty, it emphasizes gender quality and equal opportunity of both men and women to participate in development undertakings and to value the role played by each member of society. The proposed project will adhere the requirements addressed under this policy.

3.1.6 National Human Settlements Development Policy (2000)

Among the objectives of this policy is to improve the level of the provision of infrastructure and social services for the development of sustainable human settlements and to make serviced land available for shelter to all sections of the community. Such infrastructure and services constitute the backbone of urban/rural economic activities. Simplified Sewerage System is one among of the important infrastructure for the Mnyamani community and country at large

3.2 PRINCIPAL LEGISLATIONS AND REGULATIONS

The ESIA team reviewed several legislations relevant to the construction of Simplified Sewerage System. These encompass Principal Acts that support and provide guidelines to implement the intended project as discussed below.

3.2.1 Environmental Management Act (2004)

Among the major purposes of the EMA are to provide the legal and institutional framework for sustainable management of the environment in Tanzania; to outline principles for management, impact and risk assessment, the prevention

and control of pollution, waste management, environmental quality standards, public participation, compliance, and enforcement; to provide the basis for the implementation of international instruments on the environment; to provide for the implementation of the National Environmental Policy; to provide for the establishment of the National Environmental Fund and to provide for other related matters.

Part III, Section 15(a) states that "*in matters about the environment, the Director of Environment shall coordinate various environment management activities being undertaken by other agencies to promote the integration of environmental considerations into development policies, plans, programs, strategies projects and undertake strategic environmental assessments to ensure the proper management and rational utilization of environmental resources on a sustainable basis for the improvement of the quality of human life in Tanzania*". Part X of the law deals with Environmental Quality Standards. Section 140 of this act states that "*The National Environmental Standards Committee of the Tanzania Bureau of Standards established under the Tanzania Bureau of Standards Act, 1975 shall develop, review and submit to the Minister proposal for environmental standards and criteria concerning; water quality; discharge of effluent into the water; air quality; control of noise and vibration pollution; sub-sonic vibrations; soil quality, control of noxious smells; light pollution; and any other environmental quality standard*" Some of these standards have already been published in the government *gazette* while others are not in place. This project shall take into account all the standards specified by this act.

3.2.2 The Environmental Management (Fees and Charges) Regulations, 2021

These Regulations shall apply in relation to an act or service in respect of which fees and charges are payable under the Act and Regulations made thereunder. The regulations emphasize that "a person shall not, upon payment of fees and charges prescribed in the Schedule to these Regulations, carry on any of the following":

- Environmental Impact Assessment;

- Environmental Compliance Monitoring and Audit;
- Registration of Environmental Experts;
- Environmental Quality Standards;
- Noise and Vibrations; or
- other activities related to the environment

This project complies with the regulations since the proponent has already paid registration fees and review charges as directed by NEMC.

3.2.3 The Environmental Management (Control of hazardous Waste) regulations, 2021

The objective of these regulations is to protect the environment and human health by preventing or reducing the generation of Hazardous waste, the adverse impacts of the generation and management of hazardous waste and by reducing overall impacts of resource use and improving the efficiency of such use, which are crucial for the transition to a circular economy. The regulation requires that “any person generating, collecting, storing, transporting, treating, recycling, reusing, recovering and disposing of hazardous waste or any person exercising jurisdiction under these Regulations shall, assure that there are no adverse impacts to be generated or caused by the activity conducted. Project developer will comply with the requirements of this regulation by reducing the construction materials which may generate hazardous impacts, as well as proper handling of such waste such as in use of fuels for various purposes etc.

3.2.4 The Environmental Management (Control of Noise and vibration) regulations, 2015

The regulations focus on the maintenance of a healthy environment for all the people in Mainland Tanzania, the tranquility of their surrounding and their psychological well-being by regulating noise and vibration levels to prescribe the maximum permissible noise and vibration levels from a facility or activity to which a person may be exposed. The project developer will make sure that all

the guidelines under this policy will be considered to ensure the healthy environment to everyone.

3.2.5 The Environmental Management (Prohibition of Plastic Carrier bags) regulations, 2019

Regulations are meant to impose a total ban on the import, export, manufacturing, sale, and use of plastic carrier bags regardless of their thickness. Plastic carrier bags has a wide definition in the Regulations, as a bag made of plastic film, with or without handles, or gussets and to which its layer is in any thickness. The Regulations also categorically state that no person shall sell or offer for sale beverages or other commodities wrapped in plastics unless the nature of such commodities require wrappings by plastics, and restricts any licensing authority from issuing any licenses after the Regulations come into force. Project developer will make sure that there will be no use of plastic bags within the project site and the whole project life time, also in case of the need of carrier bags the proponent will make sure that there will be an alternative bags which are allowed by the regulations. For the commodities that are wrapped in plastic, then the proponent will make sure that such plastic will be handled properly.

3.2.6 The Environmental Management (Solid Waste Management) regulations, 2007

The solid waste management regulation of 2007, provides general directive on management of solid waste as follows: -

Regulation detail the requirements and responsibilities for managing solid waste in Tanzania

Highlight waste minimization and cleaner production principles alongside the duty to safeguard the public health and the environment from adverse effects of solid waste. Detail permitting requirements, notably that any person dealing with solid waste as collector, transporter, waste depositor or manager of a transfer station will apply to the LGA for a permit. The local authority will also issue licenses to individuals or companies qualified to operate solid waste

disposal sites; permit is required to operate an LGA waste disposal site. The proposed project is expected to generate solid waste in construction phase. Therefore, to comply with this regulation the Project developer will engage the registered solid waste collection contractor.

3.2.7 The Environmental Management (Water Quality) regulations, 2009

Regulations provide for institutional and legal framework for sustainable management and development of water resources; to outline principles for water resources management; to provide for the prevention and control of water pollution; to provide for participation of stakeholders and the general public in implementation of the National Water Policy. These regulations require the sustainable management of water sources and proper use of the available sources without causing any damage towards such sources. Also, the regulations emphasize that it is every one's responsibility to conserve and preserve the available water sources in Tanzania. During all phases of the project there will be water demand, hence the project developer will make sure that there will be a sustainable use of water. Also during construction and maintenance phase the developer will make sure that the water supply pipes will not be damaged in either ways

3.2.8 The Environmental Management (Air Quality) regulations, 2009

The Regulations were formed in order to: -

- Prohibit emissions and releases of hazardous substances into the environment
 - Prescribe permissible emission limits and quantities of emissions of sulphur oxide, carbon monoxide, black smoke and suspended particulate matters, nitrogen oxide, ozone, hydrocarbons, dust and lead
 - Empower NEMC to issue air pollutant emission permits, enforce compliance, undertake emergency prevention and issue stop orders
 - Set baseline parameters on air quality and emissions based on a number of practical considerations and acceptable limits and ensure protection of human health and the environment from various sources of pollution.
-

The proposed project will adhere the requirements of this Act, emission limits will be monitored to the permissible limits.

3.2.9 The Environmental Management (Soil Quality) regulations, 2009

These Regulations, made by the Minister of State under sections 143, 144 and 230 of the Environmental Management Act, concern soil pollution and soil quality standards and provide with respect to a soil protection permit and compliance system. They also concern measures of enforcement. The object of these Regulations is to

- Set limits for soil contaminants in agriculture and habitat;
- Enforce minimum soil quality standards prescribed by the National Environmental Standards Committee.

Also, the regulations require that, the contaminants of volatile organic compounds in habitat and agricultural soils shall comply with parameters and upper limits as prescribed and contaminants of heavy metals in habitat; agricultural soils shall comply with parameters and upper limits as prescribed and contaminants of pesticides in habitat and agricultural soils shall comply with parameters and upper limits as prescribed. Local government authority may prescribe special or specific measures and guidelines for soil conservation applicable to their respective areas of jurisdictions which are not below standards prescribed under these Regulations. The Project developer will comply with the requirements made under these regulations.

3.2.10 Occupational Health and Safety Act 2003

The provisions of this law require employers to provide decent working environment to employees to guarantee their health and safety. Occupational health and safety services are important for sustainable development of a country, as they reduce occupational accidents and diseases which can have huge economic burden to individuals, enterprises and the nation as whole. Improving health and safety of workers will significantly increase productivity at the workplaces to encourage more investments, increase job creation, higher morale, and job satisfaction hence industrial harmony. The law also entails

employers to fulfil obligations of ensuring safety of the equipment's used by workers and providing proper safety gears as required.

3.2.11 The Water Supply and Sanitation Act No. 12 of 2009

This is also a new legislation that provides for sustainable management and adequate operation and transparent regulation of water supply and sanitation services; provides for establishment of water supply and sanitation authorities as well as community owned water supply organizations; and provides for appointment for service providers. The main aim of this law is to ensure the right of every Tanzanian to have access to efficient, effective and sustainable water supply and sanitation services for all purposes by taking into account among others protection and conservation of water resources and development and promotion of public health and sanitation; and protection of the interest of customers. Under this law, the Minister responsible for water affairs shall establish water authority and cluster water authorities in order to achieve commercial viabilities.

3.12 Engineers Registration Act and its Amendments 1997 and 2007

The Acts regulate the engineering practice in Tanzania by registering engineers and monitoring their conduct. It establishes the Engineering Registration Board (ERB), the law requires any local or foreigner engineer to register with ERB before practicing in the country. Project developer will continue to comply as it has utilized the services of registered engineering firm for its structural designs which it will continue to use to supervise the construction process.

3.2.13 The Contractors Registration (Amendment) Act, 2008

The Contractors Registration Act requires contractors to be registered by the Contractors Board (CRB) before engaging in practice. It requires foreign contractors to be registered by the Board before gaining contracts in Tanzania. Project Developer shall comply with the law requirement during the recruitment of contractors for project implementation.

3.2.14 The Architects and Quantity Surveyors Act (1997)

The Act requires Architects and Quantity Surveyors to be involved in the project to be registered by the Architects and Quantity Surveyor Board (AQSB) before engaging in practice. It also requires foreign contractors to be registered by the Board before gaining contracts in Tanzania. Project Developer has complied with the law requirement during the recruitment of architects who have designed the project and will continue to utilize registered persons in the project implementation.

3.2.15 The Urban Planning Act (2007)

The law provides for the orderly and sustainable development of land in urban areas, to preserve and improve amenities; to provide for the grant of consent to develop land and powers of control over the use of land and to provide for other related matters. Under Section 3, among others the law seeks to improve level of the provision of infrastructure and social services for sustainable human settlement development. This act established planning authorities which include the city, municipal, town and township councils in the country which have responsibilities including:

- Secure the orderly and environmentally sustainable development of area under its jurisdiction;
- Prepare general and detailed planning schemes;
- Control building densities and access to buildings;
- Recommending approval of building schemes and subdivision of plots by developers;
- Secure cooperation of all agencies, utility bodies, land owners and other bodies and institutions involved in the preparation and implementation of planning process;

3.2.16 Public Health Act (2009)

Provide for the promotion, preservation, maintenance of public health with a view to ensuring the provisions of comprehensive, functional and sustainable public health services to the general public. Part III (e) of the act requires premises owners to keep their premises free of mosquitoes and other disease

vectors, vermin or causative agents; Section 54 prohibits causing or suffering from nuisance likely to be injurious or dangerous to health, land, premises, air or water; Part IV (c) assigns responsibility to City council to remove or appoint an agent to collect, transport and dispose solid and liquid waste and charge fees to beneficiaries of this service and responsibilities for prescribing types of wastes and guidelines for their collection and disposal; Section 101 it gives rights to any private sewer to connect it to any available public sewer to discharge foul or storm water therefore the project may connect to and discharge sewage or storm water into the available trunk main. However, the quality of the sewage should be as per agreed with the water authority.

The Contracting Authority will ensure that the project design, construction and operation does not constitute a nuisance; meets the requirements meets public health requirements

3.2.17 World Bank guidelines for Environmental Management

The main objective of this EMP is to establish a set of mitigation and monitoring measures to minimize the adverse social and environmental impacts that can take place during the implementation stage of the subproject. The measures especially focus on sensitive receptors or sensitive locations. The EMP also provides specific information about the monitoring program during construction stage including locations, frequency and reporting process. This project complies with these guidelines as it has ESMP which contains mitigation and monitoring plans of the identified impacts.

4.0 BASELINE INFORMATION

4.1 INTRODUCTION

This section provides baseline data on the relevant environmental characteristics of the project area. Much of the description of the environment is site specific. Other aspects such as that of climate and socio-economic issues are broad covering the whole Ilala City Council. The Consultant relied on primary data as collected from the site as well as secondary data and information gleaned from the literature for the project area.

4.2 PHYSICAL CHARACTERISTICS

4.2.1 Climate

The project area as compared to many other areas in Dar es Salaam city is influenced by coastal climatic conditions. The area experiences a modified type of equatorial climate.

➤ Temperature, Sun hours and Radiation

The region is generally hot and humid throughout the year with an average temperature of 29°C. The hottest season is from October to March during which temperatures can raise up to 31°C. It is relatively cool between July to September, with temperature around 20°C. The maximum sun hours is 9 experienced from August to October, from November to January the sun hours is 8 while in February to March and May to July is 7 hours and the minimum is 5 hours in April. That means from October to March the operation in the project site will probably need more electricity for the purposes of culling at the office, while during coolest monthlies which is from July to September the consumption might go down see figure 4.1



Figure 4.1: Annual temperature, sun hours and radiation of the site

The average radiation of an area is 20.3 MJ/m²/day, with 16.3 MJ/m²/day being the minimum in April and 23.7 MJ/m²/day maximum in October.

➤ **Wind Speed**

The region experiences the average wind speed of 5.74 m/s. The maximum wind speed is 7.63 m/s experienced in June which blows from the South South East (SSE) direction which means if the project site will produce and air pollutant all activities downstream of SSE direction will be prone to that pollution. The wind is calm around December to March. The climate is also influenced by the south-westerly monsoon winds from April to October and north-westerly monsoon winds between November and March.

➤ **Rainfall**

There are two main rain seasons; a short rain season from October to December and a long rain season between March and May. Figure 3.4 shows the effective rainfall received at Dar es Salaam region.

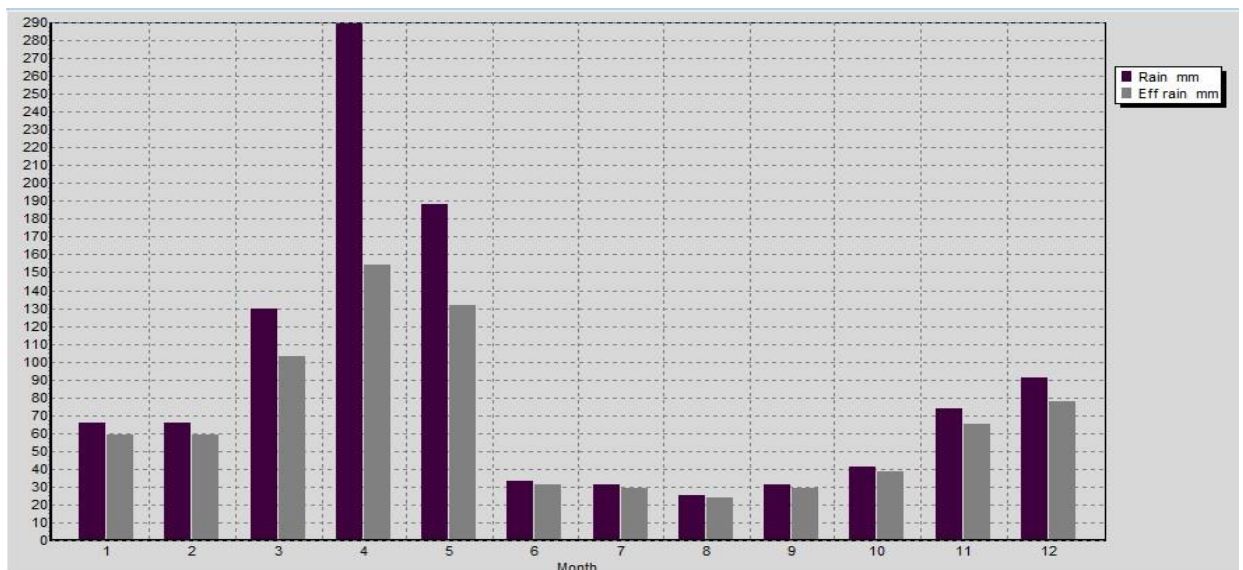

Figure 4.2: Average annual rainfall data for the site (Source Socio-Economic profile 2019)

4.2.2 Soils, Geology and Hydrogeology of the area

➤ **Hydrology**

As the area is already developed therefore it is covered by manmade drainage system along Pugu Road close to the project area. Rainwater simply flows to the public drainage system and some percolates through the soil as it easily permits percolation. No River or stream found close to the facility. However, there is potential for ground water in the project area as some surrounding buildings use borehole for their water demand.

➤ **Soils**

The soils at the project site are typical characterized with sandy and little clay with moderate humus at its upper layer.

4.2.3 Topography

The landscape of the project site is highly manipulated to make the topography flat and suitable for storage activities. The highest contour elevation at the project site is 96.5m Above Mean Sea Level (AMSL) on the western side while the lowest contour elevation is 94m AMSL at eastern part of the project site, that means the rainfall runoff at the project site are directed towards southern eastern side.

4.2.4 Air Quality and Noise Level

The ambient air quality at the project area was observed to be good because the area is for residential purposes only, just because of daily activities there will be particulate matter like dust.

4.2.5 Noise and Vibration

The noise and vibration levels at the project site are rated negligible as the only source of noise at the project site are motor vehicles using the street feeder road adjacent to the project area.

4.3 BIOLOGICAL CHARACTERISTICS

4.3.1 Flora and Fauna

Being in the municipal Centre, there are no flora species of conservation significances identified within the project site. Furthermore, there is no protected area or locations of ecological significance within the project site. The largest part of Apartment is covered with building and the remained small area

is paved with concrete floor and pass ways therefore there is no any vegetation at the site. The presence of fuel station has no significant impacts to the biological features as the project area has already developed and modified

4.4 SOCIO-ECONOMIC SET-UP

4.4.1 Administrative boundaries

Ilala Municipality bears the status of an Administrative district that lies between longitude 39° and 40° east and between latitude 60 and 70 south of the Equator. As a part of Dar es Salaam City, it is located in the extreme eastern corner of the Region, bordering by Indian Ocean for a distance of about 10 kilometers to the east. On the southern part it is bordered by Temeke and Kigamboni Municipality, whereas on its western part it is bordered by Kisarawe district and on its Northern part it is bordered by Kinondoni and Ubungo Municipality.

4.4.2 Demographic characteristics

Ilala Municipality referring to the National Population Census of 2012. The Municipality had a total population of 1,220,611 people of which 595,928 were males and 624,683 were females with sex ratio of 95. Ward wise, Vingunguti ward had the highest population of 106,946 people and Kivukoni ward had the lowest population of 6,742 people. The population of females relative to males continues to be higher in almost all wards with exception of few wards like Mchikichini, Kariakoo, Jangwani, Gerezani, Mchafukoge, Kivukoni and Upanga Magharibi (Table 4.1). The number of households was 300,674 and the average household size in the Municipality. Table 3.2 shows the population distribution by sex, average household size and sex ratio by wards in Ilala Municipality in 2012.

Table 4.1: Population Distribution by Wards and Sex (Population Census 2012)

NO	WARD	MALE	FEMALE	TOTAL	NO. OF HOUSEHOLD	SEX RATIO
1.	Ukonga	39,413	40,621	80,034	19,290	97
2.	Pugu	24,159	25,263	49,422	11,815	96
3.	Msongol a	12,147	12,314	24,461	5,704	99

Project Brief of the Proposed construction of Simplified sewerage system at Kombo Mtaa

4.	Tabata	35,909	38,833	74,742	19,527	92
5.	Kinyere zi	18,593	19,773	38,366	8,796	94
6.	Ilala	15,242	15,841	31,083	7,170	96
7.	Mchikic hini	12,977	12,533	25,510	6,465	104
8.	Vingung uti	53,248	53,698	106,946	28,994	99
9.	Kipawa	35,866	38,314	74,180	18,339	94
10.	Mnyama ni	34,547	36,038	70,585	18,380	96
11.	Kariako o	7,306	6,474	13,780	3,033	113
12.	Jangwa ni	9,174	8,473	17,647	4,190	108
13.	Gerezan i	3,767	3,509	7,276	1,589	107
14.	Kisutu	4,069	4,239	8,308	2,249	96
15.	Mchafuk oge	5,422	5,266	10,688	2,599	103
16.	Up/Mas hariki	5,461	5,706	11,167	2,756	96
17.	Up/ Maghari bi	6,786	6,690	13,476	3,135	101
18.	Kivukoni	3,531	3,211	6,742	1,343	110
19.	Kiwalani	40,247	42,045	82,292	22,120	96
20.	Segerea	40,065	43,250	83,315	19,496	93
21.	Kitunda	27,340	29,792	57,132	13,061	92
22.	Chanika	21,164	22,748	43,912	11,123	93

23.	Kivule	34,707	37,325	72,032	16,485	93
24.	G/ Mboto	27,927	29,385	57,312	14,349	95
25.	Majohe	39,550	42,096	81,646	19,588	94
26.	Kimang a	37,311	41,246	78,557	19078	90
Total		595,928	624,683	1,220,611	300,674	95

Source: Population Census August, 2012

4.4.3 Economic Activities

➤ Agriculture

Agriculture and livestock sector is another important economic activity in Ilala Municipality whereby 13% of the population is employed in the sector. The livestock kept in the Municipality are cattle, goats, sheep, donkeys, pigs and chicken. Fishing in Indian Ocean also provides employment to a sizeable proportion of the people in the Municipality

➤ Tourism

Tourism is currently one of the leading economic sectors in Tanzania and has unlimited potential to contribute even more to the development of the country. There are a number of tourist attractions at Ilala Municipal Council available are categorized into two groups of Landmarks, Museums and Art Galleries, libraries and cultural centers including Zingiziwa Zoo and historical Mango tree at Kibasila and other attraction centers. There are several Hotels and Restaurants, Bars, Recreational areas, Conference facilities to accommodate tourists in the Municipality. Among those they are famous modest ones. Travels and tours are plenty.

➤ Industrial developments

Ilala Municipality has a number of developed industries. The most significant industries include medium industries which process food, beverage and textiles, building materials, manufacturing industries and Printing. Others

include small scale industries which dominates wide range of food and textiles manufacturing printing and detergent. The small scale industries comprise hulling and milling machine and fruit processing which add value to agricultural primary products. Table 4.2 shows the size and type of industries in Ilala Municipality.

Table 4.2: Size and type of industries in Ilala Municipality.

Size of Industry	Type of Products	Number of Industries
Small Scale	Food, textiles, building material, manufacturing, printing and detergent	775
Medium Scale	Food beverage, textiles building material manufacturing industries printing tailors	359
Large Scale	Building industries detergent, assembly manufacturing, printing food beverage, metals extracts industries.	218
Total		1,352

Source: Ilala Municipal Council, 2018

4.4.4 Education

Education is an important tool needed for clear understanding, judgment and decision making in most issues ranging from economic, political and social. The Municipality has invested in education sector in different levels which are pre-primary, primary, secondary and vocational training colleges.

For the purpose of promoting education status in the region as a whole, pre-primary education establishment and development has become not only crucial but also necessary for the targeted groups. The Municipality has a total of 237 pre-primary schools out of which 121 are government owned and 116 schools are private owned. See Table 4.3.

Table 4.3: Distribution of Pre-Primary school by ownership and by Division 2018

Division	Public pre-school	Private pre-school	Total
Ilala	39	11	49
Ukonga	62	93	153
Kariakoo	20	12	31
Total	121	116	237

Source: Ilala Municipal Council, 2018

4.4.5 Economic infrastructures

➤ Railway Transport

Currently Ilala Municipality has two types of railway transport. The Tanzania Railways Corporation (TRC) starts at Ilala- Dar es Salaam to Tabora- Kigoma and the other line is to Tabora - Mwanza. The line was originally established during British colonial rule to move minerals. It now taken out both mainly for cargo carried as compared to passengers.

➤ Air Transport

Ilala Municipal Council is enjoying the services of Mwalimu Nyerere International Airport and it is the main entrance of incoming and outgoing passengers through air. The airport is managed by Tanzania Airport Authority.

➤ Marine Transport

On this side the Dar es Salaam port which is under Tanzania Port Authority is at Ilala Municipal Council and hence majority of passenger using ships and speed boats have to pass through Ilala Municipal Council. The port is the main gate way through to Zanzibar Islands and serving many of land locked countries such as Uganda, Burundi, Rwanda and Democratic Republic of Congo (DRC)

➤ Communication Networks

Communication network in the Municipality is attributed by big Companies which not only Influence Social development, but also economic development in Ilala Municipality. Main Communication Companies Operating in the

Municipal are: - AIRTELL, VODACOM, ZANTEL, TIGO, TTCL and HALOTEL. Almost all the newspapers and magazines are made available in the Municipality. The Televisions easily accessible in Ilala Municipality include ITV, TBC1, TBC 2, Star TV, East Africa Television, Capital Television, Tumaini TV, Mlimani TV, Clouds TV and Azam TV.

Tanzania Telecommunication Company Limited (TTCL) still provides services in land based telephone services. Postal services are available throughout the Municipal with at least one fully fledged postal office in each division to coordinate postal services.

4.4.6 Social Services Infrastructure

➤ Water Supply and sanitation

The coverage of the population with clean and safe water which is the right of every Tanzanian is unsatisfactory. In urban areas sewage disposal is a problem and sanitation is also inadequate. Financing for the construction and rehabilitation of urban water supplies is called for. Emphasis should be made on water schemes which can be easily maintained by the users themselves. The provision of an adequate supply of water for domestic, livestock, institutional, commercial and industrial use is the prerequisite to community health, economic and social development. Governmental, NGO and individual investment partners can pick suitable Wards to work with. Sanitation is most acute in urban centres where investment is needed in toilet facilities by households and public investment in public toilets and garbage collection and disposal.

➤ Health service

The dispensary is the first facility in the healthcare system where people's health problems are dealt with. The location and coverage of dispensaries is the first step towards realization of adequacy of health facility network in a given locality. Table 4.4 shows the distribution of these dispensaries in the Municipality for the 2018. The number of public dispensaries has remained the same for the two consecutive years. Private owned dispensaries accounted for 77.5% of all dispensaries in Ilala Municipality and only 22.5% were government

owned. Ukonga division has the highest number of dispensaries compared to the other two divisions.

Table 4.4: Distribution of dispensaries by ownership and by Division

Division	Year 2017			Year 2018		
	Public	Private	Total	Public	Private	Total
Ilala	3	42	45	3	43	46
Ukonga	27	38	65	27	40	67
Kariakoo	1	22	23	1	27	28
Total	32	102	134	32	110	142

Source: Ilala Municipal Council, 2018

The private sector has the larger number of health centres and hospitals compared to the public sector. While the public sector had 3 health centres, the private sector had 13 health centres. Likewise, the number of private hospitals was 6 while there was only 1 public hospital (see Table 4.5).

Table 4.5: Distribution of Health Centres and Hospitals by ownership and by Division

Division	Number of health centres		Number of Hospitals	
	Public	Private	Public	Private
Ilala	1	3	1	2
Ukonga	1	6	0	3
Kariakoo	1	4	0	1
Total	3	13	1	6

Source: Ilala Municipal Council, 2018

➤ **Electricity**

The main source of electricity is from TANESCO.

4.4.7 Solid Waste management

Ilala Municipality is estimated to produce about 1,100 tons of solid waste per day, basing on a generation rate of 0.8 kg per person per day. The collection rate is around 550-600 tons per day which is approximately 50-65% of all solid waste generated per day. Usually solid waste composition can be affected by

economic and consumer pattern. Feedback on waste composition is very important in evaluating the requirements or specifications for equipment need, treatment system and management plans

Table 4.8 Shows the estimated amount of solid waste generated in each ward per day

Sn	Ward	Projected Population 2017	Solid Waste production (tones)
1	Minazi Mirefu	49,011	24,505.5
2	Buyuni	28,725	14,362.5
3	Chanika	38,136	19,068
4	Zingiziwa	32,782	16,391
5	Majohe	75,702	37,851
6	Ukonga	96,895	49,947.5
7	G/Mboto	53,119	26,559.5
8	Msongola	57,300	28,650
9	Kivule	58,981	29,490.5
10	Kitunda	60,503	30,251.5
11	Kipunguni	60,180	30,090
12	Pugu Station	26,856	13,428
13	Pugu	34,101	17,050.5
14	Mzinga	33,988	16,994
15	Kisukuru	37,664	18,832
16	Kiwalani	59,874	29,937

17	Kimanga	66,355	33,177.5
18	Tabata	96,133	48,066.5
19	Segerea	51,524	25,762
20	Liwiti	56,156	28,078
21	Kipawa	83,010	41,505
22	Vingunguti	77,188	38,594
23	Mnyamani	58,360	29,180
24	Mnyamani	78,881	39,440.5
25	Kinyerezi	62,723	31,361.5
26	Bonyokwa	29,707	14,853.5
27	Jangwani	16,256	8,128
28	Mchikichini	32,524	16,262
29	Kisutu	11,057	5,528.5
30	Kariakoo	18,685	9,342.5
31	Gerezani	11,514	5,757
32	Kivukoni	9,215	4,607.5
33	Ilala	38,838	19,419
34	Up/Maghari bi	16,368	8,184
35	Mchafukoge	14,059	7,029.5
36	Up/Mashari ki	11,400	5,700

Source: Ilala Municipal Council, 2018

Note: Calculations based on the assumption that production of solid waste per day per person is 0.8 kg.

Variation in some Wards is due to business conducting during the day time where there are many people from different parts of the City

4.4.8 Waste Collection and Transportation

In regard to solid waste collection and transportation, there has been an increase in rates of solid waste collected and transported to the disposal site since 2000, when Council opted to work in partnerships with the private sector as contractors of solid waste collection and transportation, the collection rate decreased from 650 tons in 2015 to 550 tons per day 2018 and disposed off. The decrease was due to decrease of skip buckets, decrease in number of skip loaders, and decrease in number of refuse tracks notwithstanding the slightly improvements, but primary challenges that need to be addressed to further improve the situation. Primary factors contributing to low level of solid waste collection are: -

- ✓ Fast population growth resulting in daily waste generation levels that exceed the handling capacities of the council
- ✓ limited financial resources which constrain the ability of the council to secure the necessary infrastructures and appropriate equipment in adequate numbers to provide the services

4.4.9 Housing

Life forms at the project site are mixed, such that there are residential, institutional and commercial activities. Housing and settlement in the area shows that the majority of buildings have houses roofed with corrugated iron sheets while few buildings are covered with tiles. The walls of building are of concrete blocks and a small proportion of households have houses with walls built from burnt bricks and stones. On the increase is the number of houses built and later covered with glass. On the other hand, the houses of most households have tiles floors followed by those which have cement screed

5.0 PROJECT REQUIREMENTS AND WASTE GENERATION

5.1 Project requirements

5.1.1 Construction materials and labour force

The main materials for construction of Simplified sewerage system include cement, aggregates (stones), water, steel, sand, timbers, blocks, PVC pipes, and gravels. All materials are available in the local sources in Tanzania. The estimated quantities of the materials to be included in the BoQ.

5.1.2 Labour force

The labour force will be determined by the Contractor; nevertheless, it is projected that during the construction phase the project will require not less than 100 workers both skilled and non-skilled laborers for each phase of project construction.

5.1.3 Machinery and Equipment

The proposed project development will employ various standard construction equipment and machinery. Equipment expected to be used during the construction works are Tippers, Concrete Mixers, poker vibrators, Wheel barrow, Compactor, etc. All equipment and machineries for construction works needed by the proposed project will be determined when the bill of quantities (BoQ) and selection of Contractor is finalized. These equipment shall be temporary and shall be demobilized once project is completed.

5.2 Wastes generation

The major wastes generation associated with the project are solid wastes and liquid waste. The solid wastes so produced will be collected and properly disposed at the collection points ready for transportation to the dumpsite.

5.2.1 Liquid waste management

During the maximum operation phase a total of 1,650m³ per day of liquid waste is estimated to be received at the downstream receiving chamber of the Fecal sludge treatment facility close to the project site. This is based on the

assumption that 80% of the 80 liters per capita per day demand for the 25,600 people is discharged as waste water.

5.2.2 Solid waste management

From experience point of view, households connected to the simplified sewerage system tend to throw solid wastes especially used sanitary pads into their toilet sinks thinking flushing will help but the results has always been immediate blockage.

The project design will ensure installation of garbage screen at each household level to prevent the system blockage from single individual's fault. This among others will render the household with the blockage to ensure the situation is well and timely handled at their own costs.

Therefore, solid wastes should be properly disposed at the collection points waiting for solid waste pickup trucks. Table 1 below shows solid and liquid wastes to be generated by the project and the methods of their disposal.

Table 1: Management of construction and operation wastes

Solid waste		
Type of waste	Sources	Disposal / Management procedure
Biodegradable materials mainly domestic waste (food, paper, wood etc.)	- Construction crew	Accessible litter bins within the camp site and later to the city waste disposal system (engage a private company)
Non- biodegradable materials (plastic, glass)	- Construction crew	Recycling/ reuse (Plastics to be sent to plastic recyclers and glass bottles to be sent to glass recyclers)
Liquid waste		
Type of waste	Sources	Disposal / Management procedure
- Excreta (domestic) human - Grey water /cleaners	- Toilets and floor cleaning	Use of septic tanks and when full will use the constructed Simplified sewerage system for further treatment downstream

6.0 POTENTIAL IMPACTS

6.1 Positive impacts

6.1.1 Improved living conditions and economic growth

The project will improve the living conditions in Ilala Municipal specifically Kombo street whereby the project operation phase will do away with illegal faecal sludge dislodging especially during rainy season or during the night. The monthly charged fee for each connected household will be such as affordable by the intended customer. Thus, there will be increased money circulation that result into increased income consequently better standard of living of people in the project area.

6.1.2 Employment opportunities

Labour force for the project will be originated from Vingunguti Ward and the surrounding communities in Ilala areas. Even though during construction the employment will be on short term basis, employees will have been benefiting from the project. Some will witness their incomes and livelihood improvement.

6.1.3 Increased socio-cultural interaction

Increased socio-cultural interaction is another anticipated positive impact. The implementation of the project will bring many people from different cultural backgrounds. The interactions may bring about social changes in the communities around the project areas. Interaction with technocrats as a result of new immigrants (customers) into the area will stimulate adoption of the new technologies.

6.1.4 Increased Revenue to the nation through taxes, both direct and indirect

DAWASA is expected to increase its revenue collection on implementing this project. This will be through monthly payment of sanitation services by the

respective household. The revenue collected will contribute towards expansion of the water supply and sanitation service within DAWASA service area.

6.1.5 Cost reduction for sewage management

The proposed facility will make it easier for the Institutions and households which at present incur unbearable costs for proper dislodging the septic tanks when full. That simply means the households in the vicinity and the institutions will benefit through direct connection to the downstream treatment facility depending on the nature of topography.

6.2 Negative impacts

6.2.1 Increased HIV/AIDS and other sexual related diseases:

Local communities surrounding the project area have to be aware of the fact that HIV/AIDS is present in their areas but accede to it not being at an alarming rate. The communities were worried that with an influx of people into the project area the pace of spread will accelerate especially during the construction phase.

Mitigation Measures

- Contractor shall enforce a code of conduct in the project area to encourage respect for the local community and to maintain self-cleanliness of the working area at all times.
- The contractor shall deploy locally available labour to reduce risk of spreading communicable diseases (especially STDs).
- In order to prevent more HIV/AIDS infection, during the implementation phase, the project should include information education and communication component (IEC) in its budget. This will help to raise more awareness on HIV/AIDS, and means to suppress its incidence.
- A safety, health and environment induction course shall be conducted to all workers, putting more emphasis on HIV/AIDS, which has become a national disaster.

6.2.2 Land degradation and increased erosion

Establishment of new facility within the project area might result into land degradation and promote soil erosion.

Mitigation Measures

- Unnecessary trench excavation close to the buildings and sensitive re-alignments shall be avoided.
- Lined drainage channels at sensitive terrains shall be provided to control speed and volumes of storm-water.
- The contractor should plant grass or any other vegetation cover to minimise exposed soil surface.
- Directing flow to properly designated channels within the facility site.
- Timely backfilling

6.2.3 Noise pollution

Noise pollution is likely to occur due to the application of construction equipment and generators at the site.

Mitigation Measure

- The proponent shall maintain equipment in good running conditions to ensure that ambient noise level and vibrations pollution into the environment is very minimum to comply with Tanzania standards.
- The noisy construction activities will be scheduled at normal working hours. Regular inspection and maintenance of construction vehicles and equipment will be done to ensure that they have mufflers installed and worn parts are replaced

6.2.4 Air Pollution from dust emission

Air pollution is likely to occur due to the emission of suspended particulate matter (dust) to the atmosphere from the construction activities.

Mitigation Measure

- Mixing equipment shall be sealed properly and vibrating equipment will be equipped with dust removing devices.
- Also all vehicles that generate excessive black smoke will not be used.
- Adequate training and use of personal protective equipment (PPE) such as eye glasses and dust masks will be ensured in order to reduce risks associated with dust.

6.2.5 High Risk of Health associated with construction work

Construction activities exposes the workers to a lot of risks for example risk of getting into contact with fecal sludge matter, injuries, COVID-19 pandemic etc

Mitigation measure

- The project proponent shall ensure that all personnel are provided with appropriate protective gear.
- All works shall be planned and conducted in accordance with relevant OHS Guidelines. First Aid Kit as well as regular medical check-ups for the workers will be provided during the entire working hours.
- Adequate number of firefighting equipment/extinguishers will be provided in every few distance to help putting off fire in case of occurrence.
- Excavated pits should be protected by warning tape and guardrails to prevent workers and passersby from falling
- Provision of hand washing equipment and soap at every entrance and exit and at random passage ways within the construction site.
- Ensure all workers to take precautionary measures against COVID-19 by washing hands with soap frequently, practicing social distancing and using face masks of their preference.

6.2.6 Waste generation during construction

A lot of waste will be generated especially during construction stage. For example, pipework is likely going to produce some plastics which need to be

disposed of. Construction of waste water chambers will both generate wastes. Other wastes will be generated from cleaning of construction equipment and containers like mixers and paint buckets.

Mitigation measures:

- Stick to the design specifications
- Provide waste containers
- Provide training to workers and orient them towards environmental protection values

7.0 ACTION PLAN FOR PREVENTION AND MANAGEMENT OF ACCIDENTS DURING IMPLEMENTATION STAGE

The project shall be implemented in compliance to labour laws in Tanzania, in particular, the Occupational Health and Safety Act (2003). Clauses to protect the health and safety of workers shall be included in the contract documents for implementation stage.

7.1 Health and Safety

The proponent is committed to protect the health and safety of its employees and those of its contractors, to ensure that activities are conducted in a manner that protects the environment and people. The Contractor shall provide and enforce the use of appropriate personal protective equipment for all workers e.g. overalls, gloves, masks, etc. (wherever required). Tanzanian/international construction standards will be followed for quality and safety to workers. First aid facility will be installed at the construction site.

7.2 Security

The whole proposed project will take care of security matter of the site by fencing the storage area and provide gates for entrance and exit purpose. The project proponent shall have a 24 hours security services from a private company to secure the whole project premise at the site. Also since the nature of investment involves fecal sludge management facility with the potential of biogas production. The project proponent will install the best firefighting system

at site. The purpose of fire protection is to protect life, good and activities within the project site.

The following are some of the active and passive fire-fighting equipment that will be employed;

- Fire detection system
- Fire hydrant system
- Portable Fire Extinguishers

7.3 Monitoring, Maintenance and repair

The management of the facility will be upon DAWASA to ensure the approved design or plan is implemented accordingly. Furthermore, provision of basic services will be executed at high quality as intended.

8.0 ENVIRONMENTAL AND SOCIAL MANAGEMENT PLAN

8.1 Environmental and Social Management Plan

The Environmental and Social Management Plan (ESMP) presents the implementation schedule of the proposed mitigation measures for both environmental and social impacts. The ESMP for the proposed Construction of Simplified Sewerage System at Kombo street Vingunguti Ward is summarized in Table 2. The ESMP also indicates environmental costs needed to implement the recommended mitigation measures. The site selection process has been done, however engineering designs are being prepared and will soon be incorporated with the mitigation measures recommended in this report. Additional recommendations are provided in the ESMP to enable the Simplified sewerage system to be constructed and operated in environmentally friendly manner.

DAWASA shall be the main implementer of the ESMP through. The environmental measures incorporated in the detailed engineering design will be attached to the Bills of Quantities and Contract Documents. Moreover, there will be an Environmental, Social, Health and Safety (ESHS) Code of Conduct to be signed by the Contractor(s) to show their commitment in the implementation

of the Environmental, Social, Health and Safety. The implementation of the Code will be supervised by DAWASA or his consultant.

The ESHS Code is a set of Guidelines attached to the Bidding Document and Contract to be adopted by Contractor during project implementation. It contains the commitment and obligations of the Contractor and its subsidiaries (i.e. Sub-Contractors and staff) to undertake construction activities in accordance with all applicable Laws, Rules, and Regulations. The Contractor and its subsidiaries shall comply with the Code of Conduct with high ethical standards. Failure to observe the Code, will subject the firm to disciplinary action, including Contract termination. Violation of the Code, is violation of Law which may result to civil and/or criminal penalties to Contractors, Supervisors or Firm.

Some of the issues to be included in the ESHS shall include;

- Site specific **ESMP, HSMP,**
- Traffic Management Plan (**TMP**), **where applicable**
- HIV/AIDS Awareness Program,
- Occupational Health and Safety Awareness Program.
- Sexual Harassment Prevention Policy
- Child Labour Prevention Policy

The environmental and social mitigation and enhancement measures incorporated in the detailed engineering design will be attached to the Contract Documents. The Contractor shall take stock of the contents of the Project Brief.

Table 2: Environmental and Social Management Plan for the Proposed Construction of Simplified sewerage system at Kombo street, Vingunguti Ward, Ilala Municipal

Impact	Mitigation Measure	Responsible Institution	Estimated Time Cost (TZS)	One Estimated Annual cost (TZS)
Mobilization Phase				
Increased waste generation	<ul style="list-style-type: none"> ○ Stick to the design specifications ○ Provide waste containers ○ Provide training to workers and orient them towards environmental protection values 	Contractor/DAWASA/Ilala Municipal Council	To be included in the BOQ	
Noise pollution during construction	<ul style="list-style-type: none"> ○ The proponent shall maintain equipment in good running conditions to ensure that ambient noise level and vibrations pollution into the environment is very minimum to comply with Tanzania standards ○ All construction works will be scheduled at normal working hours. 	Contractor/DAWASA/Ilala Municipal Council	500,000.00	

Impact	Mitigation Measure	Responsible Institution	Estimated Time Cost (TZS)	One Estimated Annual cost (TZS)
	<ul style="list-style-type: none"> Proper inspection and maintenance of construction vehicles and equipment will be done to ensure that they have mufflers installed and worn parts are replaced 			
Construction Phase				
Increased waste generation	<ul style="list-style-type: none"> Stick to the design specifications Provide waste containers Provide training to workers and orient them towards environmental protection values 	Contractor/DAWASA/Ilala Municipal Council	To be included in the BOQ	
Increased HIV/AIDS and other STD	<ul style="list-style-type: none"> Contractor shall enforce a code of conduct in the project area to encourage respect for the local community and to maintain self-cleanliness of the working area at all times. 	Contractor/DAWASA/Ilala Municipal Council	5,000,000.00	

Impact	Mitigation Measure	Responsible Institution	Estimated Time Cost (TZS)	One	Estimated cost (TZS)	Annual
	<ul style="list-style-type: none"> ○ The contractor shall deploy locally available labour to reduce risk of spreading communicable diseases (especially STDs). ○ In order to prevent more HIV/AIDS infection, during the implementation phase, the project should include information education and communication component (IEC) in its budget. This will help to raise more awareness on HIV/AIDS, and means to suppress its incidence. ○ A safety, health and environment induction course shall be conducted to all workers, putting more emphasis 					

Impact	Mitigation Measure	Responsible Institution	Estimated Time Cost (TZS)	One Estimated cost (TZS)	Annual
	on HIV/AIDS, which has become a national disaster.				
Land degradation and increased erosion	<ul style="list-style-type: none"> o The contractor should Plant vertiver grasses to minimize exposed soil surface. o To obtain the construction materials official negotiated should be performed with wards leaders in order to avoid conflict. 	Contractor/DAWASA/Ilala Municipal Council	25,000,000		
Noise pollution during construction	<ul style="list-style-type: none"> o The proponent shall maintain equipment in good running conditions to ensure that ambient noise level and vibrations pollution into the environment is very minimum to comply with Tanzania standards 	Contractor/DAWASA/Ilala Municipal Council	1,000,000.00		

Impact	Mitigation Measure	Responsible Institution	Estimated Time Cost (TZS)	One Estimated cost (TZS)	Annual
Dust generation during construction	<ul style="list-style-type: none"> ○ All construction works will be scheduled at normal working hours. ○ Proper inspection and maintenance of construction vehicles and equipment will be done to ensure that they have mufflers installed and worn parts are replaced ○ Mixing equipment shall be sealed properly and vibrating equipment will be equipped with dust removing devices. ○ Also all vehicles that generate excessive black smoke will not be used. ○ Adequate training and use of personal protective equipment (PPE) such as eye glasses and dust masks will be ensured in 	Contractor/DAWASA/Ilala Municipal Council	3,000,000.00		

Impact	Mitigation Measure	Responsible Institution	Estimated Time Cost (TZS)	One Estimated cost (TZS)	Annual
	order to reduce risks associated with dust.				
Health Risks associated with construction works	<ul style="list-style-type: none"> ○ The project proponent shall ensure that all personnel are provided with appropriate protective gear. ○ All works shall be planned and conducted in accordance with relevant OHS Guidelines. First Aid Kit as well as regular medical check-ups for the workers will be provided during the entire working hours. ○ Adequate number of firefighting equipment/extinguishers will be provided in every few distance to help 	Contractor/DAWASA/Ilala Municipal Council	3,000,000.00		

Impact	Mitigation Measure	Responsible Institution	Estimated Time Cost (TZS)	One Estimated cost (TZS)	Annual
	<p>putting off fire in case of occurrence.</p> <ul style="list-style-type: none"> ○ Excavated pits should be protected by warning tape and guardrails to prevent workers from falling ○ The developer to ensure adequate supply of provisions ○ Adhere to good maintenance 				
Demobilization phase					
Noise pollution during construction	<ul style="list-style-type: none"> ○ The proponent shall maintain equipment in good running conditions to ensure that ambient noise level and vibrations pollution into the environment is very minimum to comply with Tanzania standards 	Contractor/DAWASA/Ilala Municipal Council	500,000.00		

Impact	Mitigation Measure	Responsible Institution	Estimated Time Cost (TZS)	One Estimated cost (TZS)	Annual
	<ul style="list-style-type: none"> ○ All construction works will be scheduled at normal working hours. ○ Proper inspection and maintenance of construction vehicles and equipment will be done to ensure that they have mufflers installed and worn parts are replaced 				
Operational Phase					
Health Risks associated with construction works	<ul style="list-style-type: none"> ○ The project proponent shall ensure that all personnel are provided with appropriate protective gear. ○ All works shall be planned and conducted in accordance with relevant OHS Guidelines. First Aid Kit as well as regular medical check-ups for the workers will be 	Contractor/DAWASA/Ilala Municipal Council		Depend on the operational manual	

Impact	Mitigation Measure	Responsible Institution	Estimated Time Cost (TZS)	One Estimated cost (TZS)	Annual
	<p>provided during the entire working hours.</p> <ul style="list-style-type: none"> ○ Adequate number of firefighting equipment/extinguishers will be provided in every few distance to help putting off fire in case of occurrence. ○ Excavated pits should be protected by warning tape and guardrails to prevent workers from falling ○ The developer to ensure adequate supply of provisions ○ Adhere to good maintenance 				
Total			38,000,000.00	38,000,000.00	

9.0 MONITORING PLAN

9.1 Environmental Monitoring

The national EIA guidelines require the developer to prepare and undertake monitoring plan of implemented development projects. Monitoring is needed to check if and to what extent the impacts are mitigated, benefits enhanced and new problems addressed. Recommendations for monitoring have been included in the Table 3. The monitoring plan also assigns responsibilities for different actors. Moreover, the ward and street environmental committees will shoulder the long-term monitoring of the project.

Table 3: Monitoring Plan for the Proposed Construction of Simplified sewerage system at Kombo street, Vingunguti Ward, Ilala Municipal

Parameter	Monitoring Frequency	Sampling Area	Measurement Unit	Method	Target Level/Standard	Responsibility for monitoring	Estimated Annual (or once cost (TZS)
Mobilization Phase							
Dust	Daily	Immediate working area	Presence of nuisance dust	Physical-visual	-	Contractor/Vingunguti ward	None
Air Quality	Daily	In and around the Faecal Sludge Plant	Presence of smells	Smelling (nasal)	Absence of nuisance smells	Vingunguti Ward/DAWASA/Ilala Municipal Council	2,500,000.00
Waste Generation	Weekly	At the working area	Amount of waste	Physical measurement or estimation	All waste contained	Contractor/Vingunguti Ward/DAWASA/Ilala Municipal Council	In BOQ
Health risks	Daily	At working area	Accidents	Counting	NO accident	Contractor/Vingunguti Ward/DAWASA/Ilala Municipal Council	In BOQ
HIV/AIDS	Monthly	Workers	Training	Numbers	One per month during construction phase only	Contractor/Vingunguti Ward/DAWASA/Ilala Municipal Council	5,000,000.00
Biodiversity	Once (at commencement)	Working area	Destruction of habitat or removal of biodiversity	Area affected	Minimal disturbance to biodiversity	Contractor/Vingunguti ward/DAWASA/Ilala Municipal Council	1,000,000.00
Construction phase							
Dust	Daily	Immediate working area	Presence of nuisance dust	Physical-visual	-	Contractor/Vingunguti ward	None

Project Brief of the Proposed construction of Simplified sewerage system at Kombo Mtaa

Parameter	Monitoring Frequency	Sampling Area	Measurement Unit	Method	Target Level/Standard	Responsibility for monitoring	Estimated Annual (or once cost (TZS)
Air Quality	Daily	In and around the Faecal Sludge Plant	Presence of smells	Smelling (nasal)	Absence of nuisance smells	Vingunguti Ward/DAWASA/Ilala Municipal Council	2,500,000.00
Waste Generation	Weekly	At the working area	Amount of waste	Physical measurement or estimation	All waste contained	Contractor/Vingunguti Ward/DAWASA/Ilala Municipal Council	In BOQ
Health risks	Daily	At working area	Accidents	Counting	NO accident	Contractor/Vingunguti Ward/DAWASA/Ilala Municipal Council	In BOQ
HIV/AIDS	Monthly	Workers	Training	Numbers	One per month during construction phase only	Contractor/Vingunguti Ward/DAWASA/Ilala Municipal Council	5,000,000.00
Biodiversity	Once (at commencement)	Working area	Destruction of habitat or removal of biodiversity	Area affected	Minimal disturbance to biodiversity	Contractor/Vingunguti ward/DAWASA/Ilala Municipal Council	1,000,000.00
Demobilization Phase							
Dust	Daily	Immediate working area	Presence of nuisance dust	Physical-visual	-	Contractor/Vingunguti ward	None
Air Quality	Daily	In and around the Faecal Sludge Plant	Presence of smells	Smelling (nasal)	Absence of nuisance smells	Vingunguti Ward/DAWASA/Ilala Municipal Council	2,500,000.00

Project Brief of the Proposed construction of Simplified sewerage system at Kombo Mtaa

Parameter	Monitoring Frequency	Sampling Area	Measurement Unit	Method	Target Level/Standard	Responsibility for monitoring	Estimated Annual (or once cost (TZS)
Waste Generation	Weekly	At the working area	Amount of waste	Physical measurement or estimation	All waste contained	Contractor/Vingunguti Ward/DAWASA/Ilala Municipal Council	In BOQ
Health risks	Daily	At working area	Accidents	Counting	NO accident	Contractor/Vingunguti Ward/DAWASA/Ilala Municipal Council	In BOQ
HIV/AIDS	Monthly	Workers	Training	Numbers	One per month during construction phase only	Contractor/Vingunguti Ward/DAWASA/Ilala Municipal Council	5,000,000.00
Biodiversity	Once (at commencement)	Working area	Destruction of habitat or removal of biodiversity	Area affected	Minimal disturbance to biodiversity	Contractor/Vingunguti ward/DAWASA/Ilala Municipal Council	1,000,000.00
Operation phase							
Dust	Daily	Immediate working area	Presence of nuisance dust	Physical-visual	-	Contractor/Vingunguti ward	None
Air Quality	Daily	In and around the Faecal Sludge Plant	Presence of smells	Smelling (nasal)	Absence of nuisance smells	Vingunguti Ward/DAWASA/Ilala Municipal Council	2,500,000.00
Waste Generation	Weekly	At the working area	Amount of waste	Physical measurement or estimation	All waste contained	Contractor/Vingunguti Ward/DAWASA/Ilala Municipal Council	In operation manual

Project Brief of the Proposed construction of Simplified sewerage system at Kombo Mtaa

Parameter	Monitoring Frequency	Sampling Area	Measurement Unit	Method	Target Level/Standard	Responsibility for monitoring	Estimated Annual (or once cost (TZS)
Health risks	Daily	At working area	Accidents	Counting	NO accident	Contractor/Vingunguti Ward/DAWASA/Ilala Municipal Council	In operation manual
HIV/AIDS	Monthly	Workers	Training	Numbers	One per month during construction phase only	Contractor/Vingunguti Ward/DAWASA/Ilala Municipal Council	In operation manual
Total							28,000,000.00

10.0 PROJECT BUDGET

The investment cost for the proposed Simplified sewerage system is estimated to be around Tshs. 1.0 billion that will be financed The World Bank.

11.0 STAKEHOLDER VIEWS ON THE PROPOSED PROJECT

During this study, different stakeholders were consulted. Among these include the Ilala Municipal Council and community at Kombo street (see Figure 6). Consultations were made through meetings.



Figure 6: Stakeholder's consultation meeting at Ilala Municipal office and Vingunguti-Kombo community

During the meeting, the consultant gave a brief explanation on the proposed Simplified sewerage system. The project description covered proposed location, type and design (a typical design was displayed). The stakeholders were given chance give their views on the project. Moreover, the consultant offered chance to clarify issues where stakeholders wanted to be given more explanations. The comments by stakeholders were analyzed and incorporated in the design of mitigation measures. Table 4 summarizes the issues raised. The names of the stakeholders consulted are given in Appendix I. While the minutes for the conducted consultation meetings with loal community are appended in appendix II.

Table 4: Stakeholders issues and concerns

Institution	Name	Position	Issues/ concerns
IMC	Ally Babu	MEHO	-For SSS if there is water shortage clogging of the system is inevitable -Public toilets should incorporate Change room and Shaving room -Proposed on-site incinerator for public toilet for pads safe disposal and privacy to women.
IMC	Xaveria Marandu	MCDO	-Educate the community to avoid the use of detrimental disinfectants to the system so as to avoid system failure and contaminated manures.
IMC	TP. Emmanuel Richard	Town Planner	-The proposed projects should help to solve community problems not bring chaos -The proposed facilities should be well protected -The provided sites for proposed projects are owned by the municipal thus no any ownership conflicts
IMC	Abdon Mapunda	Environmental Expert	-Fecal sludge drying process may take time and lead to other contamination -DAWASA should involve private owned trucks to collect foul water and not rely to their own trucks, to maximize efficiency
IMC	Ando Mwakalinga	MELWU	-Awareness to the people on the system operation, since it is a new technology
IMC	Bertha Katanzi	Architect	-Costs of using the facility should be indicative
IMC	James Batinagwa	Ag. HoD Construction	-Awareness to the community to avoid riots in the future

12.0 CONCLUSION AND RECOMMENDATION

The proposed project is of greater profit to the community and the country at large as it promotes and improve sanitation in the streets. When there is good and improved sanitation, then the outbreak of diseases like diarrhoea and associated stomach and waterborne diseases are also reduced and prevented hence improved public health.

The impacts identified are preventable and of less negativity to the community, therefore the developer can be provided with the environmental clearance certificate in order to commence the implementation of the project.

It is, therefore, concluded that implementation of the proposed construction of the Simplified sewerage system at Kombo Mtaa will entail no detrimental impacts provided that the recommended mitigation measures are adequately and timely put in place. The identified adverse impacts shall be managed through the proposed mitigation measures and implementation regime laid down in this EIS. DAWASA is committed to implementing all the recommendations given in the EIS and further carrying out the environmental auditing and monitoring schedules.





References

1. Bicknell, J.; Dodman, D., and Satterthwaite, D., (eds.), 2009. Adapting Cities to Climate Change: Understanding and Addressing the Development Challenges. London, UK: Earthscan, 397p.
2. Investment profile of Ilala Municipal council
3. Nicholls, R.J., Wong, P.P., Burkett, V.R., Codignotto, J.O., Hay, J.E., McLean, R.F., Ragoonaden, S. and Woodroffe, C.D. 2007. Coastal systems and low-lying areas. In: M.L. Parry, O.F. Canziani, J.P. Palutikof, P.J. van der Linden, and C.E. Hanson, (Eds), Climate Change 2007: Impacts, Adaptation and Vulnerability. Contribution of Working Group II to the Fourth Assessment Report of the Intergovernmental Panel on Climate Change, Cambridge University Press, Cambridge, UK, p. 315-356.
4. Population and Assets Exposure to Coastal Flooding in Dar es Salaam (Tanzania): Vulnerability to Climate Extremes
5. Ilala Municipal Socio-economic profile 2010/2011

Appendix I: List of Stakeholders Consulted

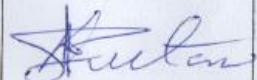
**ENVIRONMENTAL AND SOCIAL IMPACT ASSESSMENT FOR CONSTRUCTION OF OFF GRID SANITATION PROJECTS,
DAR ES SALAAM**

LIST OF STAKEHOLDERS CONSULTED

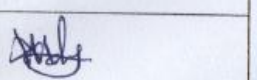
SN	DATE/TAREHE	NAME/JINA	INSTITUTION/TAASISI	POSITION/CHEO	PHONE NO./SIMU	SIGNATURE/SAINI
1	06/07/2020	Jumanne-K. Shauri	ILALA	MD	0752687524	
2	12/7/2020	KHEZI A. SULTANI	ILALA	Ag. MKIC	0713-237348	
3	13/7/2020	Reynald May	Ilala MC	Ag. Mita	0754584489	
4	13/07/2020	Charles Wambura	ILALA MC	- Afra Afya	0784842309	
5	13.07.2020	Ally Babu	- do -	Afra Afya Mwanjiri	0713065586	
6	13/07/2020	XAVIERA MABANDU	- do -	AFISA MAMWOLEO -IA JAMII	0713711228	

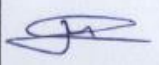
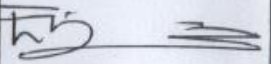
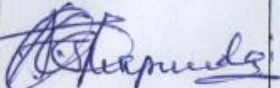
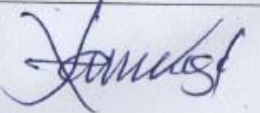
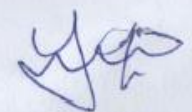
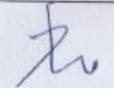

ENVIRONMENTAL AND SOCIAL IMPACT ASSESSMENT FOR CONSTRUCTION OF OFF GRID SANITATION PROJECTS,
DAR ES SALAAM

LIST OF STAKEHOLDERS CONSULTED

SN	DATE/TAREHE	NAME/JINA	INSTITUTION/TAASISI	POSITION/CHEO	PHONE NO./SIMU	SIGNATURE/SAINI
1	13/07/2020	Eng. JOHN MAGEORI	Imc	PROJECT ENGINEER	0713824546	
2	13/07/2020	TP. Emmanuel Rucuma	Imc	TOWN PLANNER	0754423147	
3	13/07/2020	Abdon Mapunda	Imc	ENVIRONMENTAL EXPERT	0715464941	
4	13/07/2020	Amo Mwanika	Imc	MCELM	0712423614	
5	13/07/20	Justine Majada	Imc	MSDREI	0712710720	
6	-	Temi Luther	Imc	Arch	0713389226	

ENVIRONMENTAL AND SOCIAL IMPACT ASSESSMENT FOR CONSTRUCTION OF OFF GRID SANITATION PROJECTS,
DAR ES SALAAM

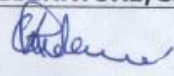
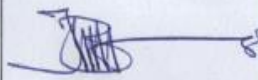
LIST OF STAKEHOLDERS CONSULTED

SN	DATE/TAREHE	NAME/JINA	INSTITUTION/TAASISI	POSITION/CHEO	PHONE NO./SIMU	SIGNATURE/SAINI
	10/7/2020	Gaudensia Kulkam	IMC	Afisa Afys Kata Kinyerezi	0712246353	
	13/7/2020	JAMES BAINALWA	IMC	KAMU MKUU LA DARU WENZI	0784224959	
	13/7/2020	BERTHA KATANZI	IMC	Mbunifu Majaripo	0752626449	

Appendix II: Minutes of Meetings with Locals

TATHIMINI YA BITHARI KWA MAZINGIRA NA JAMII WA UHAMATI	
SHATI KWA JAMII KUHUSU MPANGO WA MAKAZI KIBADALA NA	
FIBIA ZITOKANAZO NA URADI WA UJENZI WA MUNDOMBINU	
YA UHAKATATI MAJI TAKA NA VYOO VYA UMMA Mkoa wa	
DRE ES SALAM (KATA YA VINGUNGUJI)	
09/07/2020	
AGENDA	
	
1.	KUFUNGUUA KIKAO
2.	MAELEZO KUHUSU URADI WA MABOMBA YA MAJI TAKA
3.	MASWALI IMARA KUTOKA KWA WABADI
4.	KUATHIRISHA KIKAO
1.	<u>KUFUNGUUA KIKAO</u> Kikao kilifunguliwa na Mwenyekiti ndugu Saada Rawaadhani unamo muda wa saa 7:00 mchana na kisha kawatambulisha wataalamu kutoka kampuni ya Royal Associate Engineering JV G-PES LTD ikawa mcaambatana na Mwekezaji wake DAWASA.
Baada ya kutambulisho Mwenyekiti aliwakaribisha wataalamu kutoka Maelezo ya uradi.	
2.	<u>MAELEZO KUHUSU URADI WA MABOMBA YA MAJI TAKA</u> Wataalamu kutoka kampuni ya Royal Associate JV G-PES LTD ambao ni Mshawiri wa DAWASA ndugu Robert Kishiki alisimama na kufema amekuja kutambulisha uradi wa ujenzi wa Mabomba ya maji laka kabka eneo hili la vingunguti.

Mabomba haya ya maji
Kupunguza Magonjwa hasa Magonjwa ya kripindu-
-pindu. Hivyo amekuya kufanya tathmini ya Mazi-
-ngira na jamii na kukaribisha Maswali na
Maoni kuhusu huu mradi.

Shabani Saidi kutoka Dawasa alisimama na
kueleza huu mradi ni wa kuondosha maji taka
majumbani. Hivyo tunawagereza huu mtandao wa
kuunganisha mabomba ya maji taka hivyo
kwa wale ambao wanavyo vitakavyo ukara
bafi mpya watakuwepo mafundi katengemz
vyoo vya zamani na vyoo vipya, ujenzi wa
vyoo vipya. na kutakuwa na malipo kwa
Ujenzi wa vyoo binafsi vya majumbani.

Mtaalamu Adam kutoka Dawasa aliongeza na
kusema tupo katika hatua ya kufanya tathmini
ya Mazingira na jamii hivyo wananchi ni
kazima kushirikishwa ili kupata Maoni ya
na Maswali kuhusu huu mradi.

Ndugu Robert Kristiki mtaalamu Mshauri wa
Dawasa aliongeza na kusema tathmini ya
Mazingira na jamii anategemea kumaliza mu-
wa tisa mwaka huu, ili kuruhusu mradi
kuanza kwenye mwezi wa kumi.

AFISA MHEMBAJI
MTAA W. KOMBO

3. MASWALI / MABOMI KUTOKA KIWA WABATI

Athuman Juma - Alitambua kwa wote wa mabombani mabomba ni madogo na wote wanachangia zeka utakuwaje?

Said Shomari - Muesema kuna vyoo vibovu na vingine vitatengenezwa hivyo inakuwaje?

Mohamed Mohamed - Je kuna utarabiti wa kupi wanandi au ni bure?

Mtaalamu ndugu Shaban kutoka Dawa ali jibu Swala la mabomba madogo zitariba ni kuandana na matumizi yetu binafsi hivyo kama tatariba vizuri haya mabomba na kuchia kutipa makopo na pampers na Mauchapu mazito ambayo yatariba mabomba ila hata hivyo kuna nyavu zinawekwa kwenye mabomba ili kuzuia tuka ngumu.

Pia kuna vikundi vya wanandi wanaoza kushirikiana ili kuribua hizo chemba.

Kuhusu utarabiti wa vyoo kuna gharama zitakuwepo ambayo zitakuwa sio nyingi sana kwa vyoo kinyaka kabisa gharama ni laki 6 na nusu na kuendelea inategemea na fundi atakapokujia na kuona kenavyo lakini kutengwa.

APR 2024
KIBIASHIRI
KIBIASHIRI

Kuhusu kulipia utalipwa kwa awamu malipo kidogo kidogo. Baada ya kulipa gharama za chuo ile bill itaendelea kila mwisho wa kuwazi.

Said Shomari - Aliomba gharama ya kulipia ya sh 5000/= Ipungue kidogo tawe sh 3000 au sh 2000/=

Mohamed Kibwana Mohamed - Je kama mteu hataki kulipa kwa awamu na anayohela kamili laki sita ya ujenzi wa chuo itaku-balika.

Utaalamu alijibu Inakubalika.

Utaalamu Adam kutoka DAWASA alisema gharama zinazoa kubadilika kwa kuwa gharamo zinapungua na EWURA.

Mkundo mbinu yote ya kujenga mabombu itafu-nywa na DAWASA. wanandii watagharamika na 1700 ksh

Mkwana - alikuliza kama yeye hana ujenzi wa chuo Inakuwaje.

Utaalamu alijibu tutaangalia chuo kikicho kama kuna ukarabati DAWASA itajengwa na utasign ukataba ambao utakuwa unalipa kidogo kidogo ila kwa mwanzoni DAWASA itajenga chuo kwa gharama zake na baadaye utasign utalipia gharama hizi kulingana na ukataba unavyosema.

AFISA MTAJIRI
Mtaa Kombo

Udau aliuliza kama mtu anadumba kimoja
anachoo chake na mwingine anavyumba kapangi-
sha vipo vingi na wanavyo vingi hakuwaji?
Mtaalamu akajibu hilo kemelidukua kutalifa-
myia kazi

A. KUAHIRIWA KIKAO

Kikao kilialinishwa unamo muda wa saa
8.00 mchana.

Sahibi ya Mwenyekibi - SAUDA RAMADHAN,

0716-266606

Sahibi ya Mtendaji - DOMINICA P. BALAMA

AFWA MENDOJI
MWA MTAJIBU

0658-777047

UKAD CHA WANANCHI WA KOMBWA MTAJI
 JA MATAJATA KILICHOFANTIKA TAR 9/7/2020
WALIOHUDHURIA MTAJI WA KOMBO

JINA	NO SIMU	MJUMBE
1. RAMADHANI ABDU KILIINDI	0655-933764	5
2 ZAHABU THABII KOMBO	0714587319	5
3 ZAHABU ABDA SELEMANI	0718944440	5
4 RUKIA NGOJA	0710 291253	4
5 HAMISI OMARI MBENA	0782 515130	4
6 MOHAMEBI M. NGALENI	0657 512133	4
7 ZAWADI MAUBIBI KHAILALA	0716621169	3
8 JAKSONI BATRISTA NYIGO	0679658740	4
9 ISSA MOHAMEBI MANOFU	0713888550	3
10 MERE PATER MAZIKU	0754492209	3
11 JABIRI AMINU MINGUWI	0715 996840	4
12 JUMA HOSSENI MBISI	0787 727275	3
13 FATUMA SELEMANI LUBAKA	0719026209	3
14 AMINA MGENI MTINGE	0769510900	3
15 SHARIFU HAMISI KISUBA	0758079993	5
16 SELEMANI MINGOKO		
16 RAIFA SELEMANI MINGOKO	ANU SIMU	4
17 MBARAKA MADIKE		
18 SAIBI ABAMU MZOZA	0658 210815	3
19 AMABI ALLY	0682242503	4
20 KHAIIBU ISMAHILI AMIRI	0719868725	3
21 REHEMA KASSIMU ALLY	0784 562094	3
22 MAWLAZO RASHIDI SHABANI	0653907779	4
23 MILIAM SHARIFU ALLY HAMEBI	0652 662323	4
24 FATUMA ABEDI MUHANBO	0657837642	5
25 RAMADHANI MASUBI KOLONGO	0716014297	4
26 MOSI MZEE MSIMU	0717948484	4
27 ZAHNA SELEMANI PATO	0714804804	2
28 IBI SHABANI	0718 315724	4
29 SALMA HAMISI SIZITA	0686532494	4
30 MACHA NASSORO PEPO		5
31 IATU JUMA CHANGUUKU	0693795812	5
32 SIKUZANI RASHIDI HEMEBI	0758767398	3
33 JOSEFU KIBULA ONGAI	0713282748	4
34 PATERJANI KIBULA ONGAI	0716642072	4
	0718819943	4
	0712785522	4

Kombo		
JINA	No SIM	MJUMBE
MATHUDHURO		
45	0917 723719	KILIMKA
46		
47	0757-931630	KILIMKAE
48	0693-686168	PWIKU
49	0653-334425	ZAINABU
50		
51	0718-912056	KILIMKAE
52	0713-549284	KILIMKA
53	0654-286430	
54	0714 184906	ZAINABU
55	0656-8684706	
56	0714-135874	Farida
57	0787-291257	KILIMKA
58	0715-829581	ZAINABI
59		ZAINABU
60	0710-806647	KILIMKA
61	0659-286330	KILIMKAE
62	0786-731148	KILIMKAE
63	0653-965178	KILIMKAE
64	0787-979984	MITAGO
65	0783-412817	KILIMKAE
66	0715-654428	KILIMKAE
67	0658-728211	Urembo
68	0786-456308	Zainabi
69	0715-760267	KILIMKAE
70	0655-274281	Zainabu
71	0654-350874	KILIMKAE
72	0689-755642	KILIMKAE
73	0777-150200	KILIMKAE
74	0775-771916	ZAINABU
75	0675-424892	ZAINABU
76		Urembo

AFISA MANDIAJI
Mtaa B. Kombo

AFISA MANDIAJI
Mtaa B. Kombo

Kombo		
JINA	NO SIM	SHWA Nyuni
ADWINA NASSORO PEMBE	0712495454	5
6 JONATHANI KISOMA	0653586480	5
37 FATMA ALLY ATHUMANI	0654937295	5
38 RAJABU ALLY KILIMKAMU	0687189098	5
39 SALEHE MBUGI	0688252426	5
40 IBRAHIMU JUMA SAGUTI	ANA SIM	5
41 HAMISI SALUMU TUNGIE	0673517225	3
42 ZENA HOSSEN MPANI	0655607508	5
43 ASIA SAIDI LENGIE	0787354145	5
44 DIMITRY HAMISI AITUMANI	0713968436	5
45 BAKARI MWISHEHE	0679318895	3
46 NASORO JOKORO MBECU	0652233831	5
47 MAULIBI JUMA MLANZI	0653289496	5
48 SHABANI JUMA CHONGWE	0784058865	4
49 KAULETI - EDIMMO SHAO	0653-383368	5
50 SHABANI SAIDI MIKOLE	0713685510	5
51 MOHAMEDI ATHUMANI MBUBILA	0787996987	5
52 HAWI SALUMU ABDELILA	0683736088	.
53 HAMUDI HAFI BU MUKITI Kombo	0715-380706	.

Appendix III: Screening Decision from NEMC



NATIONAL ENVIRONMENT MANAGEMENT COUNCIL(NEMC)
BARAZA LA TAIFA LA HIFADHI NA USIMAMIZI WA MAZINGIRA

Telephone: +255 22 2774889,
Direct line: +255 22 2774852
Mobile: 0713 608930
Fax: +255 22 2774901
Email: dg@nemc.or.tz
Website: www.nemc.or.tz

35 Regent Street,
P. O. Box 63154
11404 Dar es Salaam
TANZANIA

In reply please quote:
EC/EIA/2021/8116

Date: 14/04/2021

Managing Director,
Dar es Salaam Water & Sewerage Authority (DAWASA),
P.O.Box 1573,
Dar es Salaam.

RE: SCREENING DECISION FOR THE PROPOSED SIMPLIFIED SEWERAGE SYSTEM TO BE CONSTRUCTED AT KOMBO STREET, VINGUNGUTI WARD, ILALA MUNICIPALITY DAR ES SALAAM REGION

We acknowledge receipt of your letter dated 10/03/2021 Submitted with Project Brief for the above mentioned project.

Following the review of the submitted documents, the Council has reached a decision that your project will end up in a Project Brief Stage. You are required to submit 10 copies of the **Detailed Project Brief** which will guide the Council in review process. However, the following should be taken into consideration to the documents;

- i) Description of all project components;
- ii) Description on Land use and Land ownership;
- iii) Discussion on waste management (generation type, quantity and management option for each identified waste type);
- iv) Baseline information for the project area;
- v) Discussion on Impacts and mitigation measure in all project phase;
- vi) Environmental Social and Monitoring Plan & Environmental Management Plan;
- vii) Decommissioning Plan(DP);
- viii) Discussion on Occupational Health and Safety issues (including emergency preparedness plan);
- ix) Stakeholder Consultation: all relevant stakeholders must consult at all levels from Mtaa, Ward, Municipal Council and Region. Their views and concerns raised should be responded by the Proponent and incorporated in the Detailed Project Brief. Consultation forms should bear **date** of consultation and each consulted stakeholder should **sign** against his/her **name** as the law requires;and
- x) Attachment of Certificate of Occupancy.

All correspondence should be addressed to the Director General

Note; The Detailed Project Brief should conform to the EIA and Audit (Amendment) Regulations, 2018 particularly Regulation 6(1) for the contents of the comprehensive project brief.

Upon submission of the reports you will be required to pay to the Council the amount given to you for review process as per generated **control number**. Thereafter, the Council will arrange for site verification visit for the proposed site as part of the review process. **However, transportation cost for the site visit team to and from the site will be covered by the proponent.**

Please, do not hesitate to contact us in case you need additional information or clarification on this process through Telephone No. +255 752364553 from Monday – Friday around 8:00am to 04:00pm.

We look forward to your cooperation on this matter.

Yours Sincerely,



Abel Sembeka

For: Director General

Cc: M/S G-Pes Limited,
P.O.Box 35539,
Dar es Salaam.

All correspondence should be addressed to the Director General

**Appendix IV: Memorandum of Understanding between DAWASA and Dar
es Salaam Municipal Councils**



MEMORANDUM OF UNDERSTANDING
BETWEEN
MINISTRY OF WATER
AND
THE DAR ES SALAAM WATER SUPPLY AND
SEWERAGE AUTHORITY,
REGIONAL ADMINISTRATIVE SECRETARIAT
AND
DAR ES SALAAM MUNICIPAL COUNCILS
(Kinondoni, Ilala, Temeke, Ubungo, Kigamboni)

JANUARY 2019

ACRONYMS

BC	Beneficiary Community
CEO	Chief Executive Officer
CPM	Critical Path Method
CV	Curriculum Vitae
DAWASA	Dar es Salaam Water and Sewerage Authority
DDCA	Drilling and Dam Construction Agency
DEWATS	Decentralized Wastewater Treatment System
DSM	Dar es Salaam
EMP	Environmental Management Plan
ESA	Environmental and Social Assessment
ESIA	Environmental and Social Impact Assessment
ESMP	Environmental and Social Management Plan
EWURA	Energy and Water Utilities Regulatory Authority
FDR	Final Design Report
FSM	Feacal Sludge Management
GIS	Geographic Information System
GoT	Government of the United Republic of Tanzania
H&S	Health and Safety
ICB	International Competitive Bidding
IFRs	Interim Financial Report
LGAs	Local Government Authorities
m ³	Cubic meter = 1,000 litres
MD	Managing Director
MKUKUTA	National Strategy for Growth and Reduction of Poverty
MoEVT	Ministry of Education and Vocational Training
MoHCDEC	Ministry of Health, Community Development, Gender, Elderly and Children
MoU	Memorandum of Understanding
MoW	Ministry of Water
NCB	National Competitive Bidding
NEMC	National Environment Management Council

NGO	Non-Governmental Organization
NWSDS	National Water Sector Development Strategy
O&M	Operations and Maintenance
PAP	Projected Affected Person
PERT	Program Evaluation Review Technique
PIM	Project Implementation Manual
PIP	Program Implementation Plan
PO	Private Operators
PO-RALG	Presidents Office Regional Administration and Local Government
PPRA	Public Procurement Regulatory Authority
RAP	Resettlement Action Plan
RAS	Regional Administrative Secretary
RS	Regional Secretariat
RFP	Request for Proposals
SDG	Sustainable Development Goal
SPS	Small Piped Water Supply
TBS	Tanzania Bureau of Standards
ToR	Terms of Reference
UWSA	Urban Water and Sewerage Authority
WC	Water Committee
WSDP	Water Sector Development Program
WSS	Water Supply and Sanitation.
WSSP	Water Sector Development Program
WSSPII	Second Water Sector Support Project

**A MEMORANDUM OF UNDERSTANDING
FOR THE IMPLEMENTATION OF THE OFF- GRID WATER SUPPLY AND
SANITATION PROJECTS UNDER THE SECOND WATER SUPPLY AND
SANITATION PROJECT USING EARMARKED FINANCING**

Memorandum of Understanding (“MoU”) between the Ministry of Water on one part and the Dar es Salaam Water Supply and Sewerage Authority (“DAWASA”), the Dar es Salaam Regional Secretariat (RS), and the five municipalities of Dar es Salaam (collectively referred to as “the MUNICIPALITIES”) on the other part.

WHEREAS in recognition of the importance and contribution of the water sector to the social and economic development of the United Republic of Tanzania, the Government has developed a water sector support framework set out in the following documentation: (a) the National Strategy for Growth and Reduction of Poverty (“MKUKUTA, as amended”), (b) the National Water Sector Development Strategy (“NWSDS”) and (c) the Water Sector Development Program (“WSSP”).

WHEREAS after being satisfied with the objectives of the WSSP II, parties to this Memorandum have expressed their willingness to participate fully in its implementation;

WHEREAS The WSSPII project development objective is to strengthen the capacity for the integrated water resources planning and management in the united Republic of Tanzania and improve access to water supply and sanitation services in an operationally efficient manner in Dar es Salaam. The project has four components namely: Integrated Water Resources Management, Dar es Salaam Water Supply improvement, Dar es Salaam Sanitation Improvement, and Project Management and Implementation support.

WHEREAS the project is being financed by IDA Credit through Investment Project Financing, the recipient has declared its commitment to the objectives of the Project.

WHEREAS on the other part DAWASA has committed itself to the principle of harmonization and strive for the highest degree of alignment with the Government’s budgetary and accountability systems and local financial framework so as to enhance effective implementation, reduce the administrative burden on the Government, and minimize transaction costs; and

NOW THEREFORE, the parties hereby agree to cooperate in coordinating the implementation of the off-grid water supply and sanitation part of WSSP II in accordance with the principles and procedures set forth in this MoU; provided, however, that in case of any conflict between the provisions of this MoU AND THE PROJECT Financing Agreement, the provisions of the Financing Agreement shall prevail.

1. DEFINITIONS

Unless the context otherwise requires, several terms defined in the Preamble of this MoU have the respective meanings set forth therein, and the additional terms referred to below have the following meanings:

1. **Off Grid water supply** means the activities which will provide water supply services to people of Dar es Salaam, who are not connected to the formal network. The proposed solutions include decentralized Interventions, which may be an interim measure to be integrated to the grid network as it expands in the future. Schemes to be implemented include mostly independent water supply distribution systems supplied from point sources (e.g boreholes) or a bulk water supply from the DAWASA distribution system. In areas where the existing grid network is not available, independent stand-alone Small Piped Water Supply (SPS) systems will be implemented. These projects, typically involve a source of water (for example, borehole), a community-based distribution system and water points at a community and/or household level. The operations and maintenance will be supported from the tariff collected from the users.
2. **Off-Grid Sanitation** means activities which will provide sanitation services in Dar es Salaam to areas without access to sewers. This activity will support installation of improved toilets; safe emptying and transportation of the waste to a treatment facility; and treatment and safe disposal of treated waste into the environment. This will include piloting decentralized systems and other new technology.
3. **Environmental and Social Management Framework or ESMF** means the framework dated September 2006, prepared by the Government and cleared by the International Development Association, setting forth an environmental and social screening process that will enable WSSP II Implementing Agencies to identify and assess potential adverse environmental and social impacts, and offset and reduce them to acceptable levels, or enhance positive impacts, and in accordance with which environmental and social management plans will be prepared by WSSP II Implementing Agencies.
4. **MKUKUTA II** Means the Government's National Strategy for Growth and Reduction of Poverty dated July 2010, covering the period from 2011 – 12 to 2016 – 17 and subsequent versions that may be introduced by GOT.
5. **Resettlement Policy Framework** or RPF means the governing framework dated September 2006, prepared by the Government and approved by the International Development Association, for land acquisition, resettlement and compensation under the WSDP, and in accordance with which resettlement action plans will be prepared,

as necessary, as the same may be amended from time to time with the concurrence of the International Development Association;

6. **WSSP Implementation Manual** means the Project Implementation Manual (PIM) specifying implementation arrangements for the Second WSSP, including institutional arrangements; procedures for procurement, disbursement of funds, financial management, environmental and social management, and monitoring and evaluation; and progress reporting requirements, including annexes to the said manual.
7. **Project Management Team** means a team set up by DAWASA for day to day management of the off-grid water supply sub-project. Same for management of off-grid sanitation sub-project.
8. **Facilitation Team** A team appointed by the Municipal Director of the respective Municipal Council from Dar es Salaam region for the purpose of facilitating the implementation of the Off-Grid water supply projects and Off- Grid Sanitation projects. The scope of their responsibility are detailed in the PIM and summarized in this MoU.

2. UNDERLYING PRINCIPLES

2.1 The MoW, DAWASA, RS and Municipalities agree that the following are the underlying principles that govern this partnership:

- (a.) Commitment to the fulfilment of the aspirations of the National Development Vision 2025;
- (b.) Compliance with defined budgeting, procurement and public financial management rules and regulations;
- (c.) Good governance and accountability of the Government to its citizens, including an active fight against corruption;
- (d.) Coordinating the implementation of the off-grid water supply and sanitation sub-projects cost effectively; and
- (e.) Each party executing its respective roles in a timely manner

3. GENERAL PROVISIONS

3.1 Purpose

This MoU outlines the responsibilities of the **MoW, DAWASA, RS and Municipalities** with respect to the implementation of off-grid water supply and sanitation sub-projects and sets forth common institutional, environmental and social measures, monitoring and evaluation, audit and reporting arrangements. The WSSP II Implementation Manual complements procedures and arrangements set out in this MoU.

3.2 **Status of the MoU**

This MoU is not intended to create any legally binding obligations and the parties take due cognizance of the separate sector laws and regulations between the Government Institutions, and this MoU is adopted pursuant to and subject to any such regulations. In case of any conflict between the provisions of this MoU and the project Financing Agreement, the provisions of the Financing Agreement shall prevail.

4. **OFF GRID WATER SUPPLY**

4.1. **Commitment**

The DAWASA declares its commitment to the objectives of the **Second Water Sector Support Project** and will act with due diligence and efficiency to facilitate the successful implementation of the projects. To this end, DAWASA, as an Implementing Agency will effectively carry out its roles and responsibilities in the implementation of the off-grid water supply and sanitation sub-projects as defined in the WSSP II Project Implementation Manual. The Ministry of Water, as the Responsible Agency for WSSP II will have overall responsibility for the coordination and implementation of the off-grid water supply and sanitation sub-projects.

4.2 **Institutional Arrangements**

The institutional framework for overseeing the implementation of the WSSP II comprises the following key bodies, as set out in the Sections below, and in greater detail in the WSSP Implementation Manual:

1. Ministry of Water;
2. Prime Minister's Office Regional Administration and Local Government;
3. Ministry of Health, Community Development, Gender, Elderly and Children
4. Municipal Councils
5. Beneficiary Communities ("BC");

4.2.1 **Ministry of Water (MoW)**

The MoW will be responsible for provision of overall coordination and oversight. The Ministry will also provide technical and administrative support in the implementation of WSSP II, including without limitation the following activities:

1. Coordinating and consolidating the quarterly WSSP II IFRs (Interim Financial Report); semi-annual and annual progress reports; and ensuring that funds earmarked for implementation of WSSP II activities are duly considered in the annual work plans

and budgets of the implementing agencies; and that the WSSP II procurement plans are consistent with WSSP II work plans and budgets;

2. Ensuring quality and consistency of the documents referred to in subparagraph (a) above prior to consolidation as indicated in the Programme Implementation Manual and submission to the Off-Grid WSS SC for discussion;
3. Monitoring the implementation of the Annual Work Plans and Budgets by the WSSP II Implementing Agencies, at least on quarterly basis;
4. Providing oversight on financial management, controls, audit and reports; and
5. Ensuring that management decisions made by the Off-Grid WSS Steering Committee are communicated to the Implementing Agencies, implemented and monitored.

4.2.2 DAWASA

DAWASA will be responsible for overall coordination and implementation of off grid water supply activities. The off-grid water supply shall be implemented under the Directorate of Infrastructure Development (for construction arrangements) in collaboration with the Communication Unit (for coordination arrangements). The Communication Unit will be generally responsible for:-

1. Coordinating inputs as required from other units within DAWASA such as Procurement, Technical Services, and Finance, etc.
2. Supervising and monitoring contracts / agreements
3. Setting up Sub-project Agreements with beneficiary communities
4. Monitoring and reporting overall progress of the off-grid water supply sub-component.
5. Reviewing and evaluating the operation and management of the water supply sub-projects.
6. The financial aspects for off- grid water supply sub-projects will be managed as per Project Implementation Manual VOLUME II, and
7. Overall supervision of off-grid water supply activities.

4.2.3 Municipal Councils (or DLGAs)

The five Dar es Salaam Municipal Councils, through their respective Urban Planning Department, Legal Unit, Municipal Health and Water Department, will be responsible for the following tasks:

1. Creating awareness and mobilization of the communities.

2. Each DLGA will form a Municipal Facilitation Team comprising different specialists from Water, Health, Education, Community Development departments that will be tasked to assist consultants/contractors/PO on implementation and operation of Off Grid Water Supply facilities in their respective areas.
3. DLGAs through Legal unit, Health and Water department will coordinate the formation of Water Supply by-laws and regulations and thereafter enforcing for sustainability of Off Grid Water Supply facilities.
4. DLGAs will be responsible for identification and facilitation of Land acquisition for construction of Off- Grid Water Supply facilities

4.2.4 WSS Steering Committee

Given the multiplicity of institutions with varying roles, a WSS Steering Committee (SC) will be set up under the project to ensure coordination, synergy, and dovetailing. This SC will be newly set up or be adopted from some of the other projects (for example, Dar es Salaam Metropolitan Development Program [DMDP]) which may have similar steering mechanisms. This steering committee will be chaired by the Head of the Water Sector from RS and DAWASA will provide the secretary to WSS SC.

The RS will chair the Off Grid WSS Steering Committee, which will be comprised of representatives from the DAWASA, RS, WRBO, MOW, DLGAs i.e Temeke, Ilala, Kinondoni, Kigamboni and Ubungo. The Steering Committee will be responsible for providing general oversight of the selection and approval of sub-projects for implementation by the Off-Grid Water Supply and Sanitation. The key responsibilities of the Off Grid WSS Steering Committee include:

1. Reviewing overall Off Grid Sanitation implementation arrangements
2. Reviewing and approving Off Grid Sanitation sub-project operational guidelines
3. Reviewing and approving Off Grid Sanitation sub-project proposals
4. Reviewing overall Off Grid Sanitation progress and performance and providing guidance for improvements if needed
5. Conflict Resolution as per PIM.

4.2.5 Beneficiary Community

At the project level, Beneficiary Community will be involved in the project appraisal, that includes identification of sources, selection of appropriate sites, kiosk locations, and

protection of water source and infrastructures. DAWASA will be responsible for the efficient operation and management of the water supply systems.

4.2.6 Private Operator

The Private Operator (PO) may be engaged if the expansion of DAWASA grid network is beyond five years away. The PO would primarily have as its members the households from the community, with an operating body selected by the members from among themselves, with additional membership from DAWASA/DLGA. The regulation of these systems, including the tariff, would be undertaken by EWURA, as part of the overall regulation of the sector in Dar es Salaam.

Private Operator will operate, maintain, and manage the scheme under contract with DAWASA.

The Private Operator shall be responsible for keeping and maintaining appropriate records of its business activities. These shall include:

1. Customer details
2. Operation and maintenance records including volume of water produced and sold
3. Asset register, work as executed records, manuals of plant and equipment
4. Condition and expected life of assets
5. The details of network expansions as up to standards.
6. The Private Operator shall prepare monthly and quarterly operation and maintenance
7. Reports for the completed off-grid water supply subproject
8. Billing and payment records
9. Business accounts and financial statement

In general, the Operation and Maintenance Reports will address such issues as:

1. Number of registered customers in the service area
2. Number of people in the service area and number of people served
3. Business plan and budget
4. Level of service; proposed and actual
5. Revenue and expenses, progress against budget
6. Customer satisfaction
7. Maintenance activities, breakdowns, failures
8. Availability of ground /reliable water sources
9. Availability for land resources for project activities
10. Manage non-revenue water in the business area

4.3 SELECTION CRITERIA

DAWASA, in consultation with the five municipalities Ilala, Temeke, Kinondoni, Kigamboni and Ubungo will identify communities which are eligible for the Off-Grid Water Supply sub-project under the WSSP II. The identification will follow the criteria below;

1. High population density
2. Low-income areas
3. Prevalence/risk of waterborne diseases
4. No wholesome water services
5. Near-trunk infrastructure
6. Availability of sufficient land for the interventions
7. Unplanned settlements
8. Community willingness

Each of these criteria will be allocated a score, and the communities prioritized according to their total score. Keeping in mind the decisions of other interventions (for example, The Dar es salaam Metropolitan Development Program - DMDP), WSSP-II will invest in those communities which have the highest need.

5.0 OFF-GRID SANITATION

5.1 Definition.

The Off-Grid Sanitation components will provide much needed improvements to wastewater management services in areas of Dar es Salaam that are not served by DAWASA network. These improvements will be realised as a result of construction of Off-Grid sanitation stand-alone projects such as Decentralized Waste Water Treatment Systems (DEWATSs), faecal sludge treatment facilities, and condominial/simplified sewerage. The Off-Grid Sanitation Services will address the lack of sanitation services in unserved areas.

5.2 Institutional Arrangements

A strategy to address the poor sanitation in Dar es Salaam requires clarity and coordination among the various institutions involved in the sector. However, institutional responsibility is fragmented and unclear, being divided between National Ministries, City Utilities, Municipal Organizations, Regulatory Authorities, Community-Based Organizations, the Informal Private Sector and sanitation users themselves.

Currently sanitation service delivery is undertaken by a mixture of Utilities, Municipalities and Regulators. DAWASA will be responsible for overall coordination and supervision of Off-Grid sanitation activities. Other institution as detailed in PIM are summarised below:

1. MoHCDGEC,
2. MoW,
3. RS,
4. DLGAs,
5. NGOs,
6. PO

5.2.1 Ministry of Water

Ministry of Water will be responsible with setting Policy and guidelines specific to FSM and overall project coordination and implementation support .

5.2.2 DAWASA

DAWASA will provide a foundation and resources for the overall implementation of Off-Grid Sanitation.

Directorate of Infrastructure Development will be the department within DAWASA responsible for overseeing the implementation of the WSSP II including Off-Grid Sanitation Sub component. The head of this department will report directly to the DAWASA Chief Executive Officer and will generally be responsible for:

1. Coordination of the Off-Grid Sanitation Steering Committee as well as establishing a general agenda and timetable for Steering Committee meetings with consultation with Steering Committee Chairperson and providing secretariat services.
2. Coordinating inputs as required from other Directorates within DAWASA such as Procurement, Infrastructure Development, and Finance, etc.
3. Signing, supervising and monitoring contracts / agreements
4. Setting up Sub-project Agreements with successful communities.
5. Monitoring and reporting overall progress of the Off-Grid Sanitation
6. Reviewing and evaluating the operation and management of the community sanitation schemes.

In support of Sub Component 3.2: a Sanitation coordination team led by PO-RALG - Regional Secretariat will be established to coordinate implementation of the Off- Grid sanitation services. The technical department in the municipalities in coordination with DAWASA will be responsible for implementation of the off-grid sanitation component. DLGAs through Health, Legal unit and Water departments will coordinate the formation or improvement of existing Sanitation by laws and regulations and thereafter enforcing them for the sustainability of Off Grid Sanitation facilities. Areas where these facilities will be built people will be required to connect. DLGAs will be responsible for identification and facilitation of Land acquisition for construction of Off- Grid Sanitation facilities, and management of Public toilets.

5.2.3 MoHCDGEC/MoW:
Policy and guidelines specific to FSM.

5.2.4 DLGAS under Regional Secretariat:

Roles and responsibilities of the DLGAs will include:

1. Creating awareness and mobilization of the community
2. Formulation of Municipal Facilitation Team comprised of specialists from Water, Health, Education, Community Development departments that will be tasked to assist consultants/Contractors/PO on implementation and operation of Off Grid Sanitation facilities
3. Coordination of the formation of Sanitation by-laws and regulations and thereafter enforcing them for sustainability of Off Grid Sanitation facilities through Legal unit, Health and Water Department
4. Identification and facilitation of land acquisition for construction of Off- Grid Sanitation facilities
5. Establish and capacitate the grievance redress mechanism (GRM) team
6. Monitor and evaluate project implementation, trouble shooting and responding to grievances raised by Grievance Redress Mechanisms (GRM) teams
7. Prepare and submit to WSS SC a monthly project implementation progress report

5.2.5 WSS Steering Committee

Given the multiplicity of institutions with varying roles, a WSS Steering Committee (SC) will be set up under the project to ensure coordination, synergy, and dovetailing. This SC will be newly set up or be adopted from some of the other projects (for example, Dar es Salaam Metropolitan Development Program [DMDP]) which may have similar steering mechanisms. This steering committee will be chaired by the Head of the Water Sector from RS and DAWASA will provide the secretary to WSS SC.

The RS will chair the Off Grid WSS Steering Committee, which will be comprised of representatives from the DAWASA, RS, WRBO, MOW, DLGAs i.e Temeke, Ilala, Kinondoni, Kigamboni and Ubungu. The Steering Committee will be responsible for providing general oversight of the selection and approval of sub-projects for implementation by the Off-Grid Water Supply and Sanitation. The key responsibilities of the Off Grid WSS Steering Committee include:

1. Reviewing overall Off Grid Sanitation implementation arrangements
2. Reviewing and approving Off Grid Sanitation sub-project operational guidelines
3. Reviewing and approving Off Grid Sanitation sub-project proposals

4. Reviewing overall Off Grid Sanitation progress and performance and providing guidance for improvements if needed
5. Conflict Resolution as per PIM.

5.2.6 Private Operator (PO):

The domestic private sector will be a major institution which will require to be involved for sanitation in low-income settlements. Their involvement will include approaches to empty faecal sludge from latrine pits and septic tanks. This could be through vacuum trucks, or in areas where access is difficult, small 'gulper' technologies.

Private Operator will form the basic unit for planning and eventually operating and managing the community-based sanitation schemes implemented under the off-grid sanitation. Off-grid sanitation POs, will be responsible for:

1. Possession of necessary registration as per requirements.
2. Undertaking training and development in operations and maintenance, financial management, monitoring and reporting.
3. Operating and maintaining the off-grid sanitation Scheme in a sustainable manner and providing equitable access to the service for everyone in the community
4. Maintaining adequate records and reporting on technical and financial performance to DLGAs and DAWASA.

5.2.7 NGOs/ Consultant:

NGO will be responsible for Capacity building, mobilization of community; media campaigns

DAWASA will contract with a reputable NGO active in the DAWASA service area as implementing agents for the off- grid Sanitation. The key roles of the off-grid sanitation NGO include:

1. Mobilising community groups to identify all sanitation needs and raising awareness within community groups about sanitation issues.
2. Assisting community members to obtain legal status if required and to set up the necessary bank accounts, for the community to qualify for funding from micro finance institution for toilet improvements.
3. Undertaking a needs analysis and preparing a subproject proposal design, budget, impact assessment, operational and maintenance of the sanitation facility
4. Preparing subproject proposals in association with the community members for consideration by the off-grid sanitation Steering Committee.
5. Sensitization and training of POs to operate, maintain, and manage off-grid sanitation systems.

6. Assisting DAWASA to develop suitable O&M guidelines/manuals and financial management guidelines for use by the POs in operating and managing the completed schemes.

5.3 SELECTION CRITERIA

DAWASA, in consultation with the five municipalities Ilala, Temeke, Kinondoni, Kigamboni and Ubungo will identify communities which are eligible for Off-Grid Sanitation sub-project under the WSSP II, in the eligible project area using the criteria mentioned in the PIM. The criteria will include the availability of land resources for the project activities as additional criteria.

Each of these criteria will be allocated a score, and the communities prioritized according to their total score. Keeping in mind the decisions of other interventions (for example, DMDP), WSSP-II will invest in those communities, which have the highest need.

The five municipalities will be the focal point for planning, prioritizing, and implementing the off-grid sanitation in their areas. A comprehensive master sanitation plan, based on empirical data and evidence, will form the basis for this planning and implementation.

The results of the ongoing efforts to map the city on the said indicators, will form the basis for the planning efforts by the stakeholders.

Summary of Institutional Roles for Sanitation Provision

MoH/MoW/PO-RALG	Policy and guidelines specific to FSM
MoW	Overall project coordination and implementation support
EWURA	Regulate performance of DAWASA
DAWASA	Facilitating the establishment and operation of treatment facilities (FSM and the like and facilitating the development of options for transportation and treatment of this waste, establishment and management of public toilets; regulating the services of transporters
Municipalities	Facilitating the upgrading of unimproved household toilets to improved ones and regulation of waste disposal; facilitating the availability of land for decentralized systems; provide licenses to private transport operators
Private sector	Development of infrastructure for transportation and treatment, operation
NGOs	Capacity building, mobilization of community; media campaigns

TBS	Setting up of standards for effluent disposal
NEMC	Regulation of disposal of effluent

6.0 EFFECTIVENESS AND DURATION OF MoU

6.1. This MoU will become effective on the date of signature by all parties.

6.2. This MoU shall remain in force until end Closure of the Second WSSP, or as shall be mutually agreed by the parties hereto.

7.0 AMENDMENTS

This MoU may be amended at any time with the written agreement of the parties hereto.

8.0 CONFLICT RESOLUTION

In the event of any differences arising with respect to the provisions of this MoU, the parties will endeavour to find a solution through dialogue and consultation.

9.0 INFORMATION AND NOTICES

9.1. The parties to this MoU will furnish to each other all such information in relation to the WSSP II as will be reasonably requested in a timely manner.

9.2. Any notices or documents given, made or sent by the parties in relation to this MoU will be in writing and will be deemed to have been duly given, made or sent to the organization or person to which it is addressed at the time of its delivery by hand, mail, or courier at its respective address, as listed in this MoU.

9.3. Any party hereto may, by written notice to the other parties, change the address to which any notice or request for the Participant so giving such notice will be addressed.

9.4. All communications and documents submitted to any party and by any part will be in the English language.

9.5. The following addresses are specified for purposes of Section 16.2.

9.6 FOR THE PARTIES

Permanent Secretary

Ministry of Water

Address

Tel:

E-mail:

Chief Executive Officer

DAWASA

Address

Tel:

E-mail:

Region Administrative Secretary

Dar es Salaam Region

Address:

Tel:

E-mail:

Municipal Director

Temeke Municipal Council

Address:

Tel:

E-mail:

Municipal Director

Ilala Municipal Council

Address:

Tel:

E-mail:

Municipal Director

Kinondoni Municipal Council

Address:

Tel:

E-mail:

Municipal Director

Ubungo Municipal Council

Address:

Tel:

E-mail:

Municipal Director







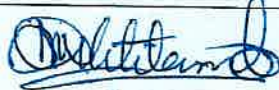

Kigamboni Municipal Council

Address:

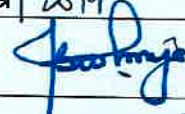
Tel:

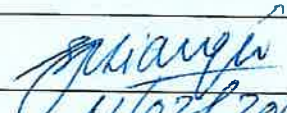
E-mail:

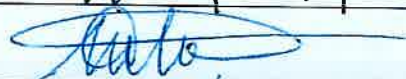
Signed by the duly authorized representatives of the parties as hereunder:

Permanent Secretary Ministry of Water	
	Date 18/2/2019
Regional Administrative Secretary Dar es Salaam	
	Date 1/2/2019
CEO DAWASA	
	Date 23.01.2019
Municipal Director Temeke	
	Date
Municipal Director Ilala	
	Date 11/02/2019
Municipal Director Ubungo	
	Date 07/02/2019
MD Kinondoni	
	Date 07/02/2019
Municipal Director Kigamboni	
	Date 09/02/2019

Appendix V: Letter from Ilala Municipal showing the permit to use the area for the project

HALMASHAURI YA MANISPAA YA ILALA
BARUA ZOTE ZIPELEKWE KWA MKURUGENZI WA MANISPAA

S. L. P. 20950
SIMU: 2128800
FAX NO. 2121486



Ofisi ya Mkurugenzi,
1 Mtaa wa Mission
S. L. P. 20950,
11883 - Dar es Salaam.

Kumb. Na. IMC/EE.22/1/50

Tarehe: 11/12/2020

Afisa Mtendaji Mkuu,
Mamlaka ya Maji safi na Maji taka-DAWASA,
Kanda ya Ilala,
S.L.P 1573,
DAR ES SALAAM.

YAH: KURUHUSU UJENZI WA MIRADI YA DEWATS KATIKA MAENEO
YALIYOPENDEKEZWA

Husika na kichwa cha habari hapo juu.

2. Baada ya ziara ya ukaguzi wa maeneo yaliyopendekezwa ambayo ni Zingiziwa, Kivule na Kinyerezi ili kujenga miradi ya uchakataji maji taka (DEWATS) iliyofanywa na timu ya wataalamu kutoka Ofisi ya Mkurugenzi wa Manispaa ya Ilala ambayo ni:-

- i. Idara ya Ujenzi – Heri Athumani
- ii. Idara ya Ardhi - Ramadhani Chamwite
- iii. Idara ya Mipango miji – Alfred Mbyopyo
- iv. Idara ya Mazingira – Shabani M. Yusuph

3. Tumejiridhisha kwamba hayana athari kwa mazingira kulingana na umuhimu wake, hivyo basi tunaruhusu ujenzi wa miradi hiyo ufanyike katika maeneo hayo ili kuboresha usafi wa mazingira kwa jamii zinazoishi maeneo yanayozunguka miradi.

4. Asante kwa ushirikiano.

Abdon Mapunda

Kny: **MKURUGENZI WA MANISPAA**

Appendix VI: Approved Architectural Drawings

VING-KOMBO SIMPLIFIED SEWER

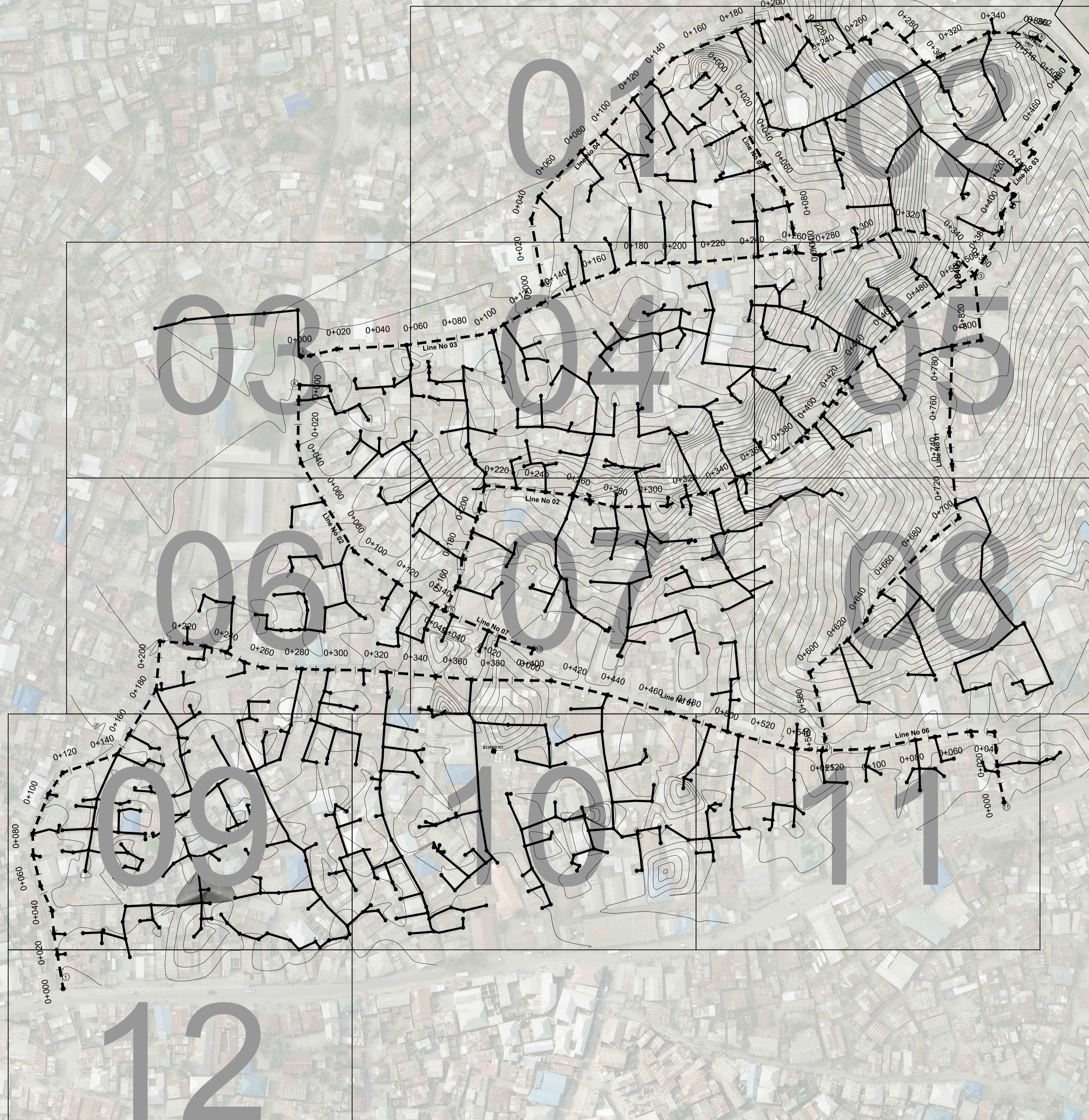

KEY:

Symbol	Meaning
	Existing culvert
	Existing Road
	Electric pole
	Telephone pole
	Trees
	Existing buildings
	Cemetery
	Contour lines
	Existing Drain
	Block sewer within elevation range
	Street Collector Sewers
	Block Sewer below elevation range
	Existing Manhole Type 1
	Existing Manhole Type 2
	Manhole Type 1
	Manhole Type 2
	Benchmark

Client: **THE UNITED REPUBLIC OF TANZANIA**
DAWASA Chief Executive
 P. O. Box 1573
 Dunga/Malanga Street, Mwananyamala
 Dar es Salaam, Tanzania

Consultant: **DOHWA ENGINEERING CO., LTD**
 In Association with **LUPTAN CONSULTANTS LIMITED** and **WWS Design & Development Co. Ltd**
 DOHWA Engineering Co., Ltd
 LUPTAN Consults Ltd

Project: Provision of Facilitation and Technical Services for Creation of Essential Framework Conditions, Capacity Building, Preparation of Detailed Engineering Designs and Bidding Documents, and Construction Supervision of the Off-grid Sanitation Works in Dar es salaam

Rev	Date	Description	Drawn	Check	Appr.

Designed: _____
 Drawn: _____
 Checked: _____
 Approved: _____
 Scale: **1:1250**
 Date: **June, 2021**

Title: **VINGUNGUTI - KOMBO SIMPLIFIED SEWERAGE SYSTEM**
KEY SITE LAYOUT PLAN
 Rev. No: **01**
 Drawing No: **SSS-IMC-101**

VING-KOMBO SIMPLIFIED SEWER



KEY:

Symbol	Meaning
	Existing DAWASA Pipe
	Block Sewer
	Collector Sewer
	Electric pole
	Telephone pole
	Trees
	Existing buildings
	Contour lines
	Existing Drain
	Existing Manhole Type 1
	Existing Manhole Type 2
	Manhole Type 1
	Manhole Type 2

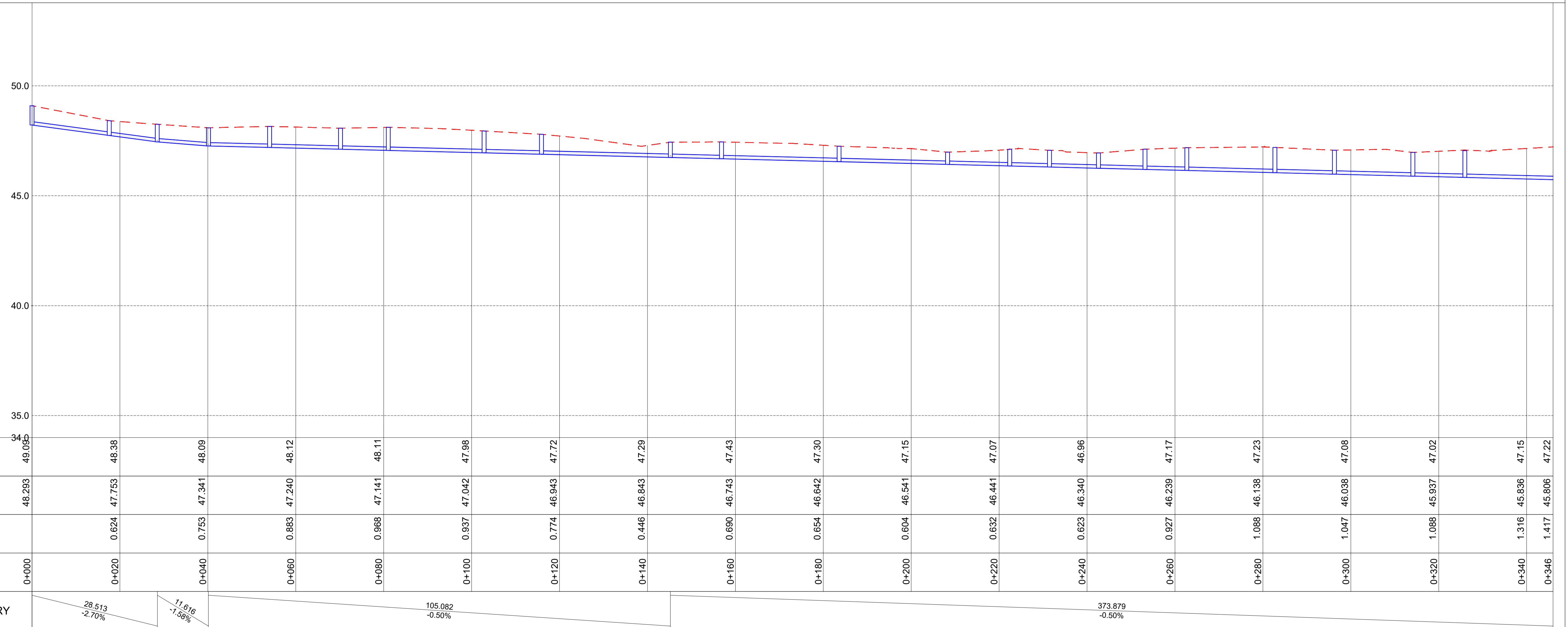

Client:
THE UNITED REPUBLIC OF TANZANIA
 DAWASA Chief Executive
 P. O. Box 1573
 Dunga/Malanga Street, Mwananyamala
 Dar es Salaam, Tanzania

Consultant:
DOHWA ENGINEERING CO., LTD
 In Association with
LUPTAN CONSULTANTS LIMITED
 DOHWA Engineering Co., Ltd
 LUPTAN Consults Ltd
 WWS Design & Development Co. Ltd

Project:
 Provision of Facilitation and Technical Services for Creation of Essential Framework Conditions, Capacity Building, Preparation of Detailed Engineering Designs and Bidding Documents, and Construction Supervision of the Off-grid Sanitation Works in Dar es salaam

Rev	Date	Description	Drawn	Check	Appr.

Designed: _____
 Drawn: _____
 Checked: _____
 Approved: _____
 Scale: **1:500**
 Date: **June, 2021**

Title:
VINGUNGUTI KOMBO SIMPLIFIED SEWERAGE SYSTEM
PLAN AND PROFILE FOR LINE No 01
 0+000.00 to 0+346.00
 Rev. No: **01**
 Drawing No: **SSS/IMC/PP 201**

STANDARD DETAILS

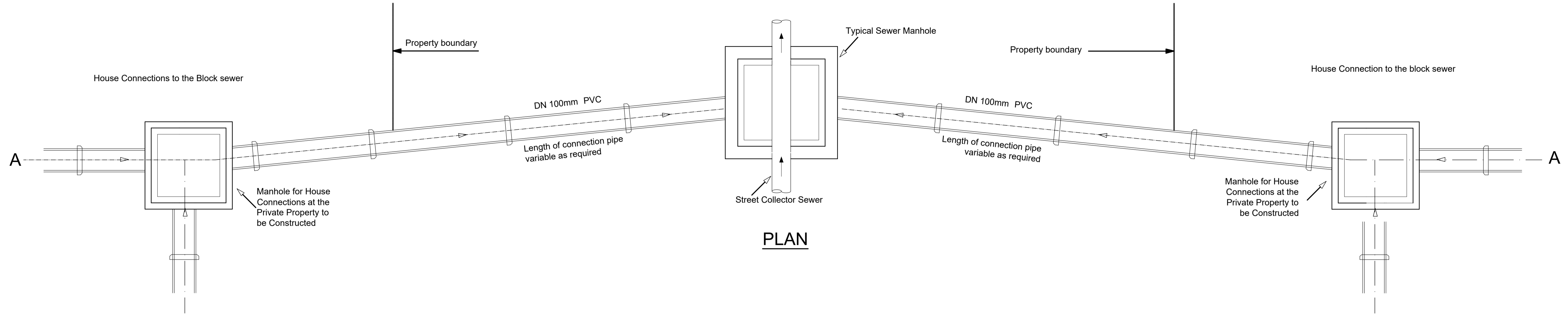

PLAN

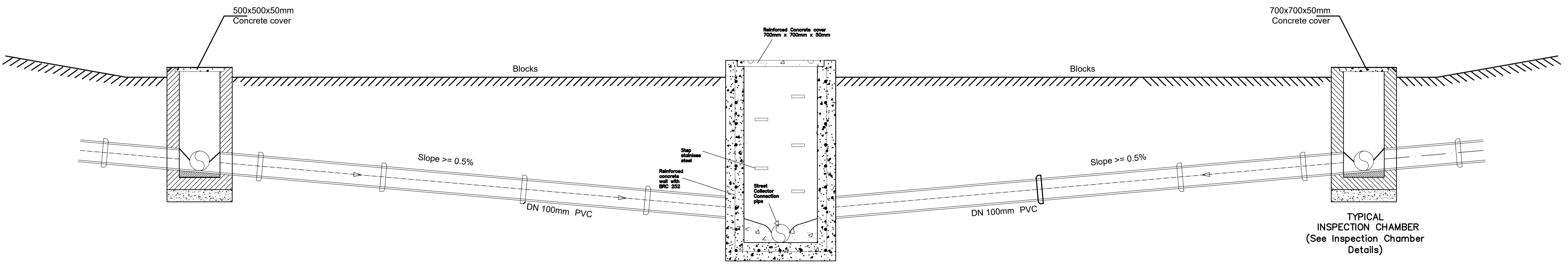

SECTION A-A

Client:



THE UNITED REPUBLIC OF TANZANIA
 DAWASA Chief Executive
 P. O. Box 1573
 Dunga/Malanga Street, Mwananyamala
 Dar es Salaam, Tanzania

Consultant:



In Association with



and

WWS Design & Development Co. Ltd

DOHWA Engineering Co., Ltd

LUPTAN CONSULTS Ltd

Project:

Provision of Facilitation and Technical Services for Creation of Essential Framework Conditions, Capacity Building, Preparation of Detailed Engineering Designs and Bidding Documents, and Construction Supervision of the Off-grid Sanitation Works in Dar es salaam

Rev	Date	Description	Drawn	Check	Appr.

Designed:	Drawn:
Checked:	Approved:
Scale:	Date:
NTS	June, 2021

Title:	
SIMPLIFIED SEWER SYSTEM STANDARD DETAILS DRAWINGS	
TYPICAL HOUSE CONNECTION DETAILS	
Rev. No:	Drawing No:
01	SSS/MC/STD 302

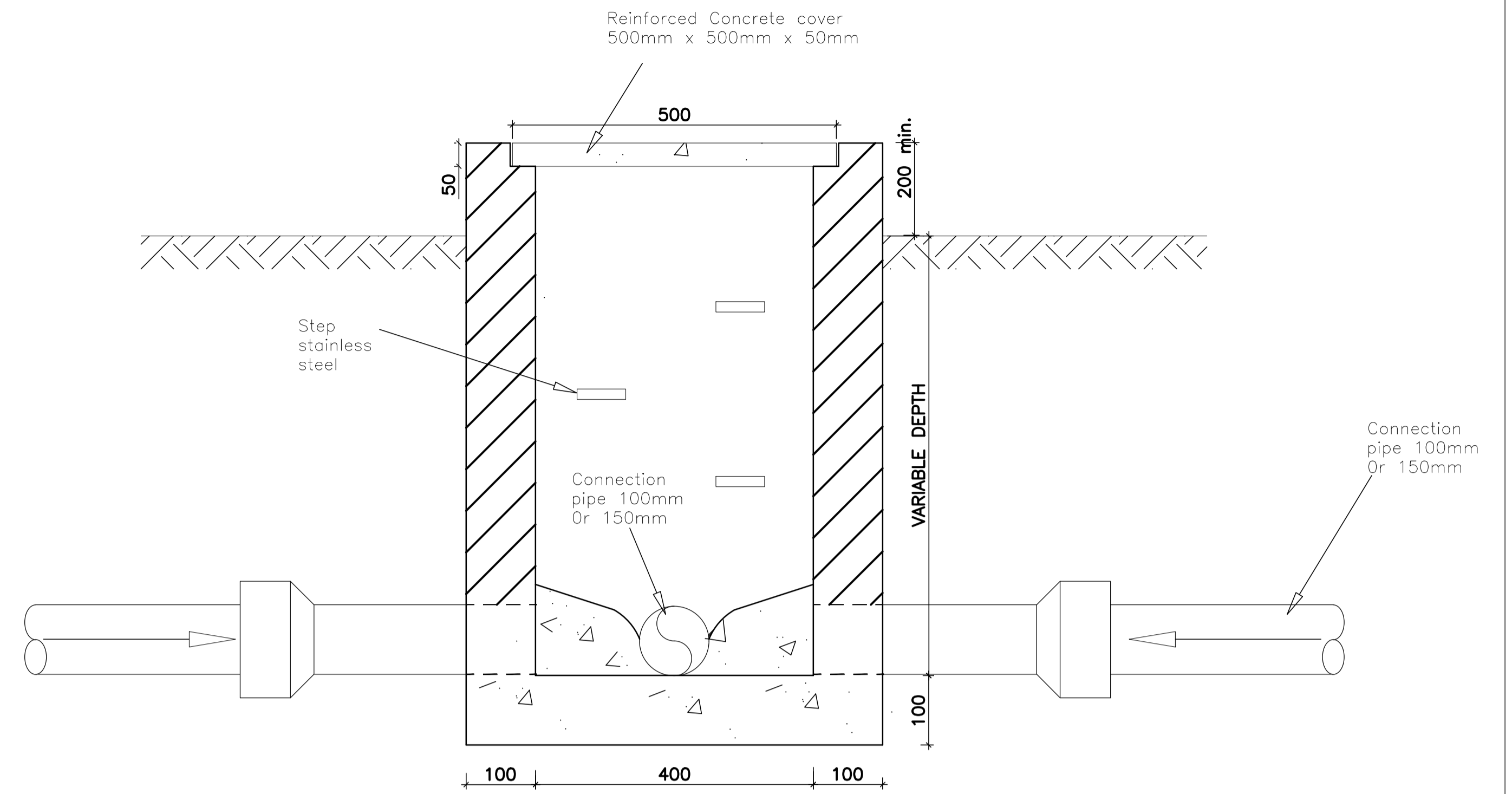
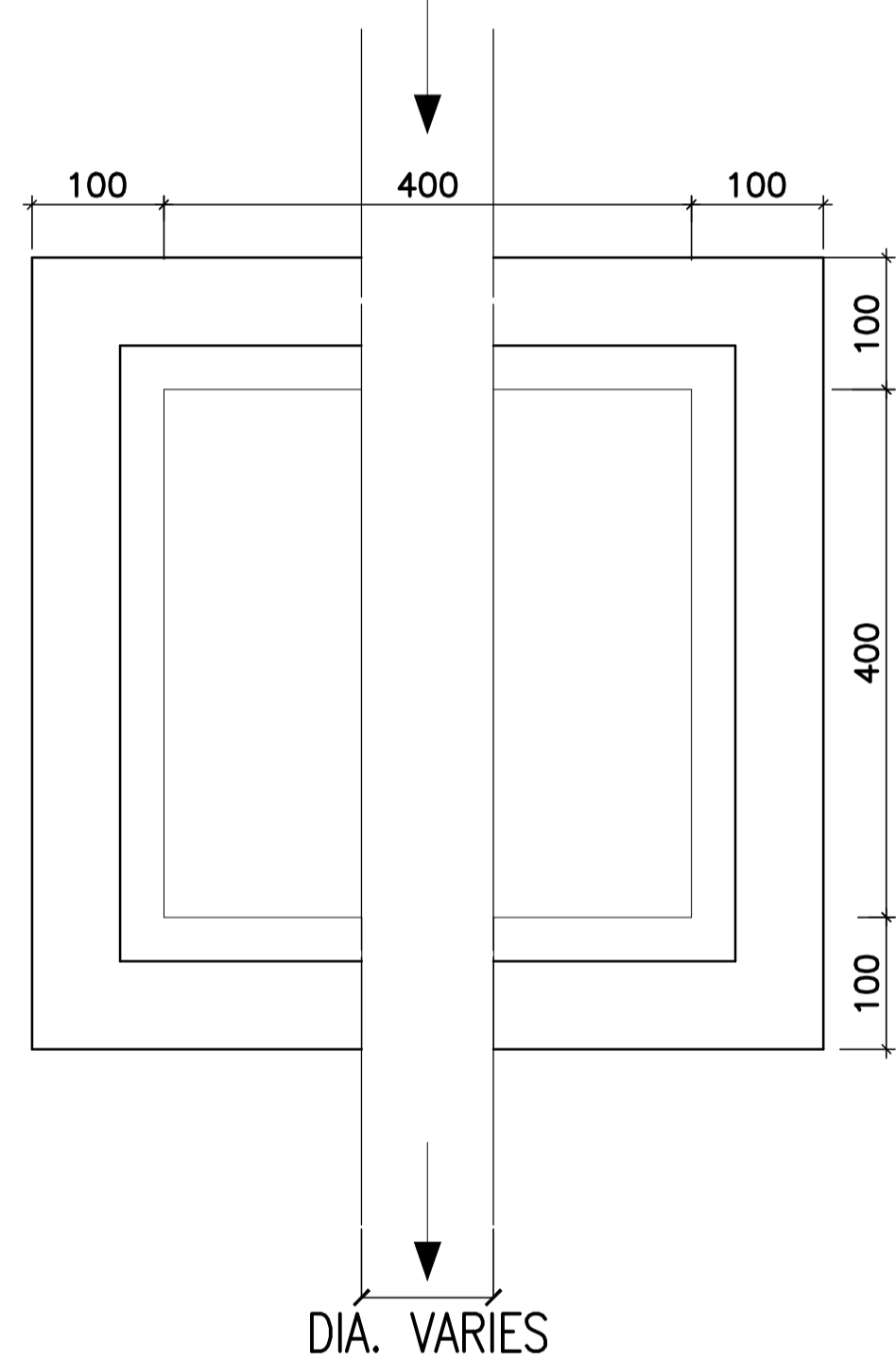
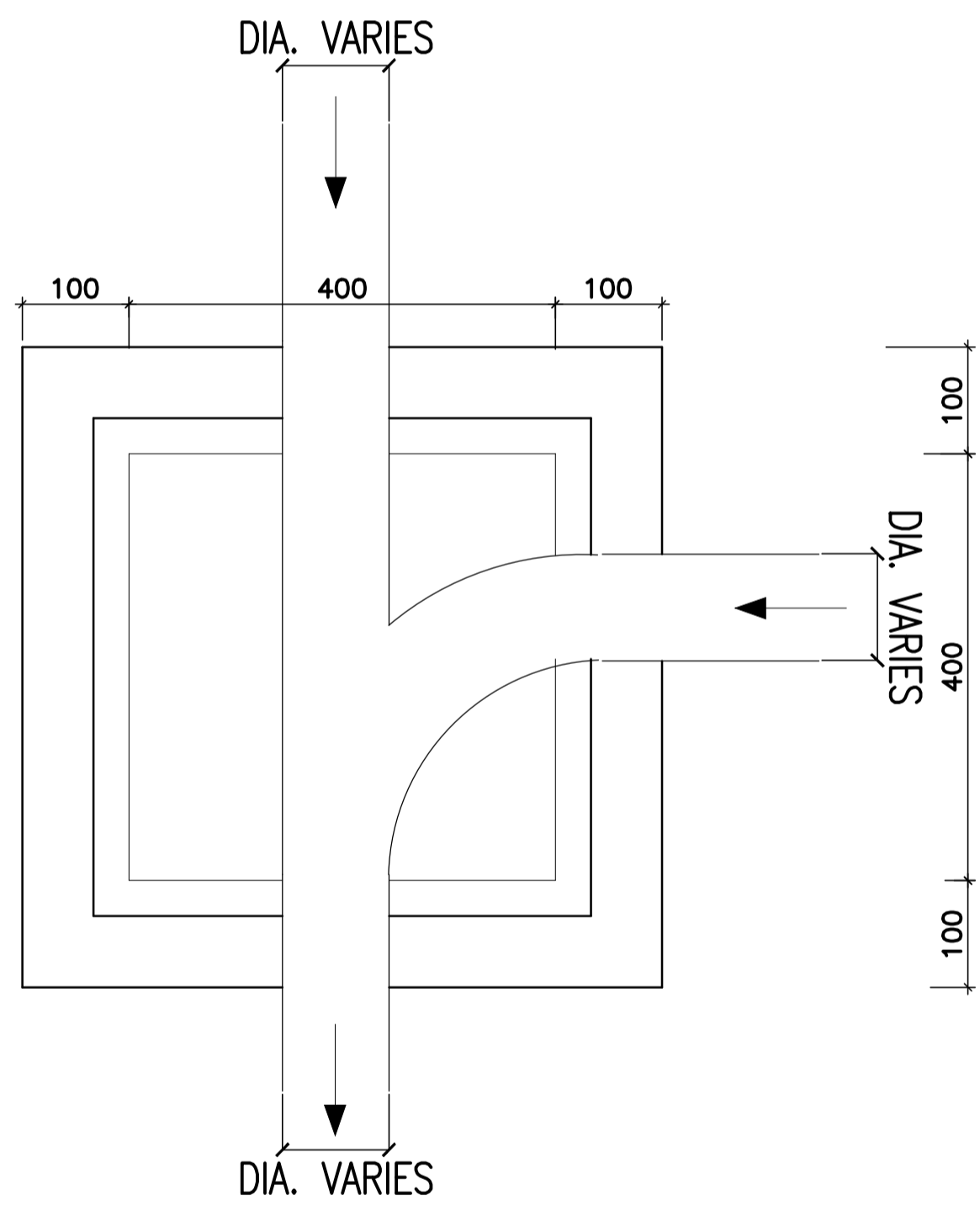
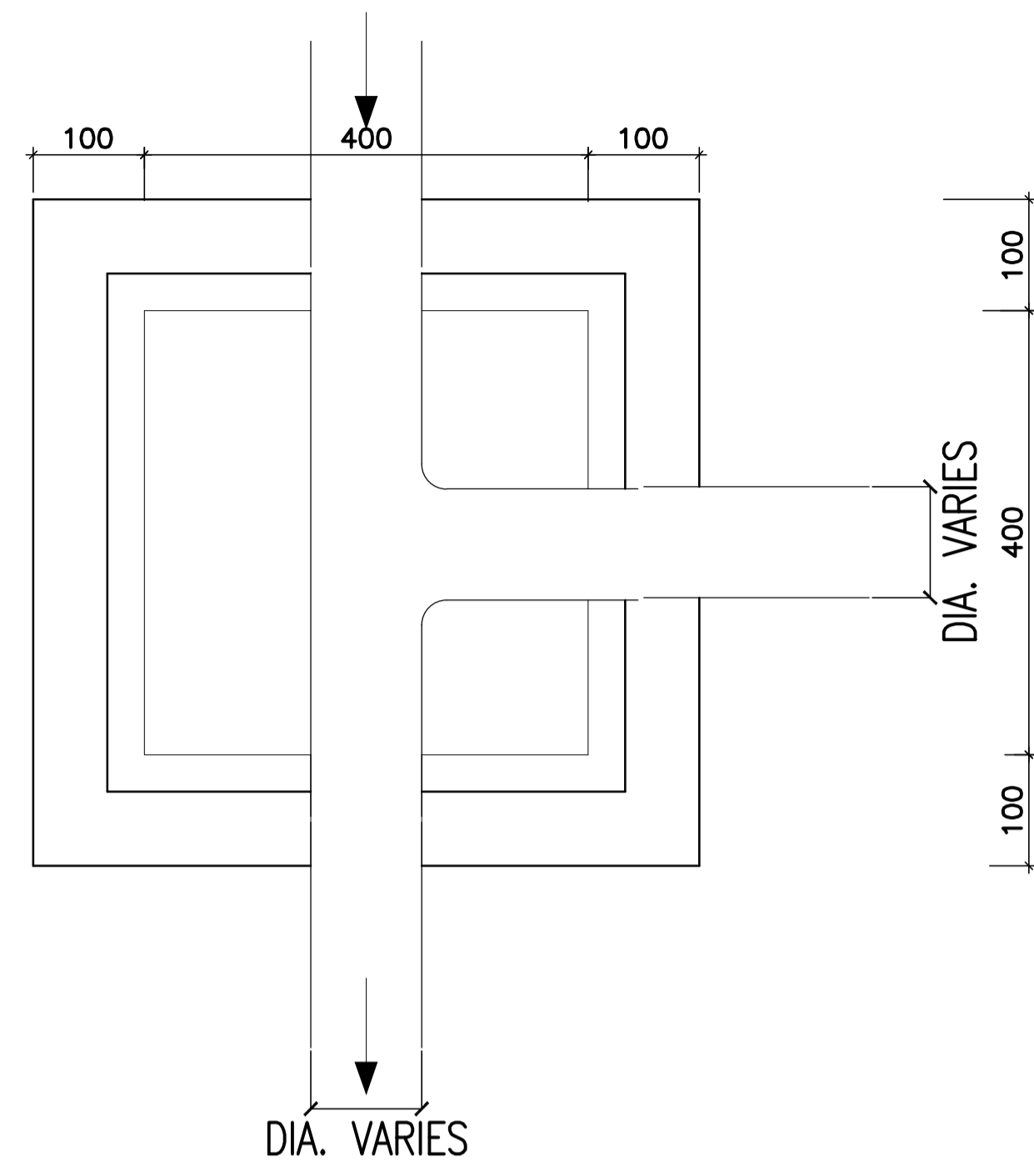
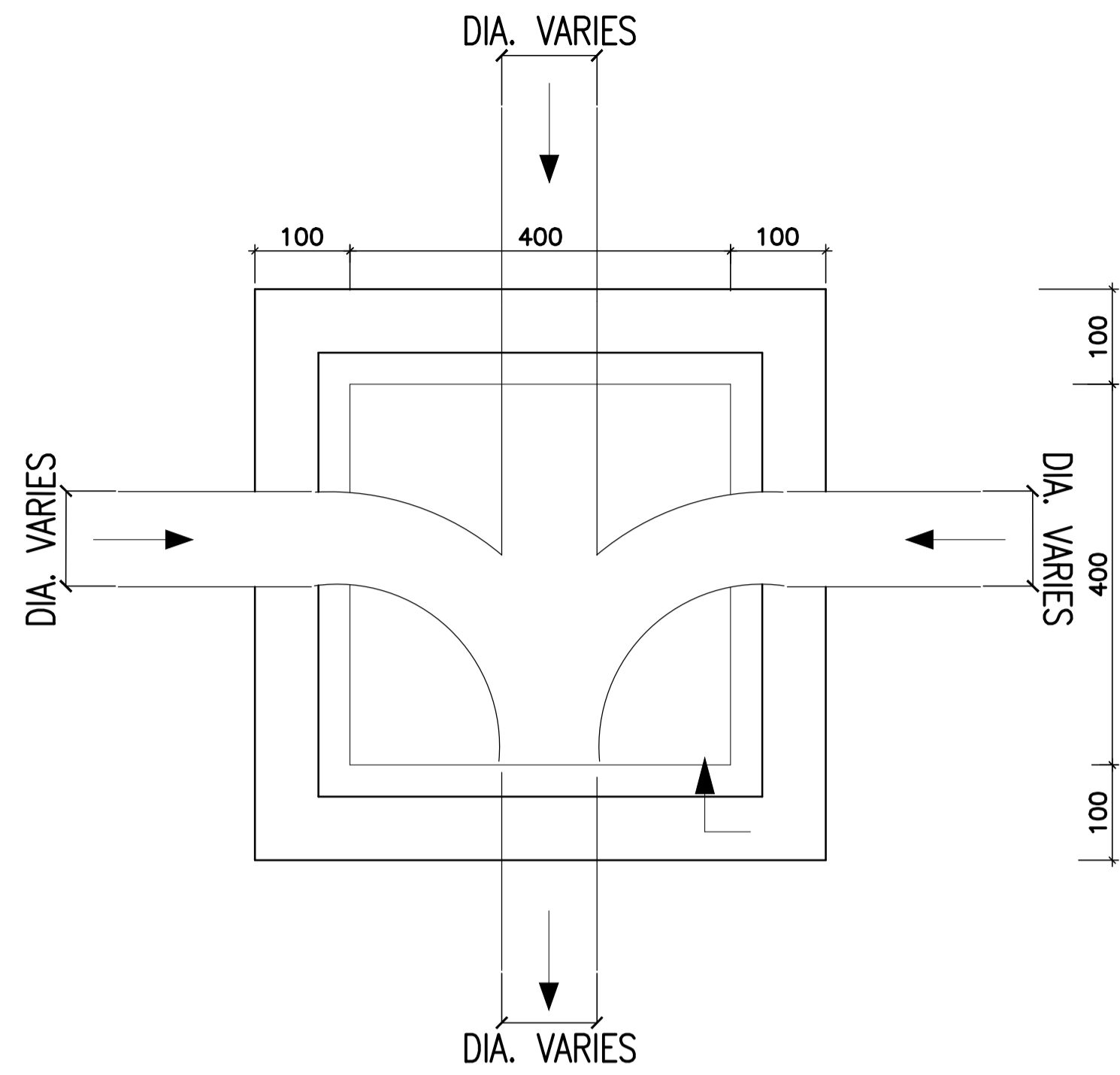

SECTION A-A

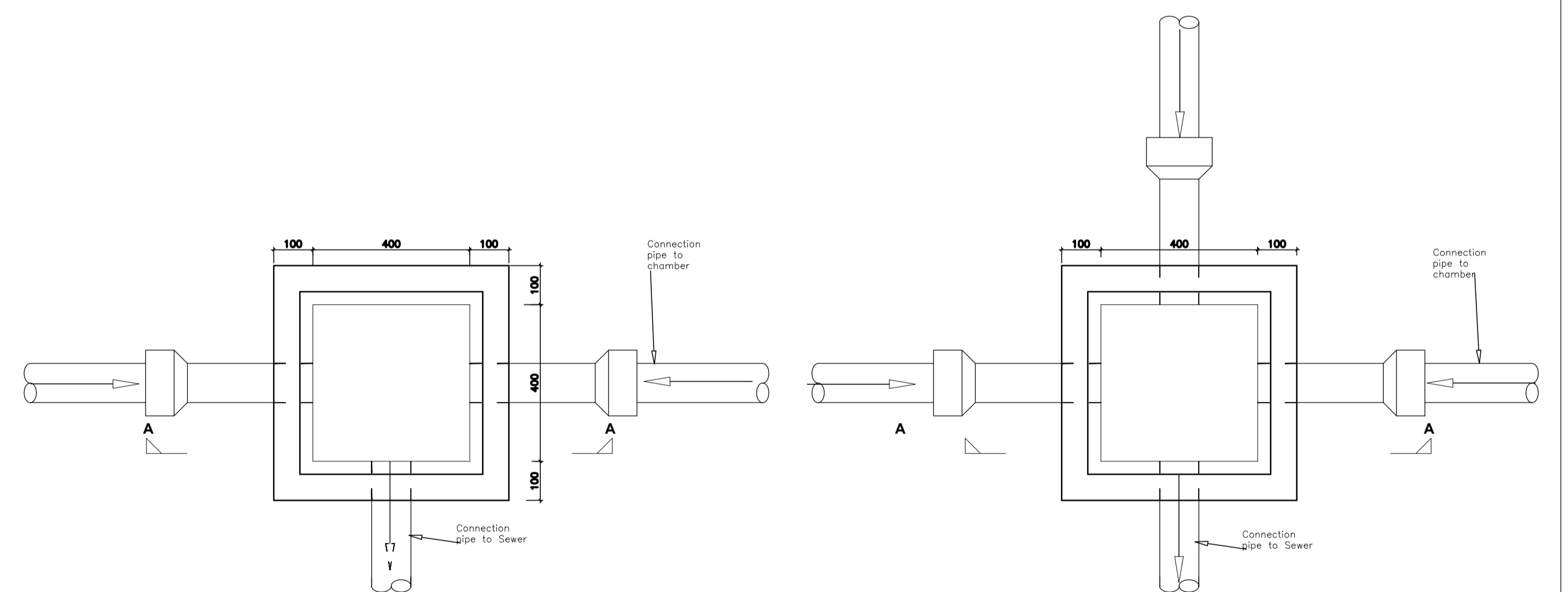

PLAN INSPECTION CHAMBER CONNECTIONS TYPE I

PLAN INSPECTION CHAMBER CONNECTIONS TYPE II

STANDARD MESH DETAILS FOR CONCRETE REINFORCEMENT

TYPE	WIRE SPACING		WIRE DIAMETER		WEIGHT/SQUARE METERS (kg/m ²)
	Main mm	Cross mm	Main mm	Cross mm	
A252	200	200	08	08	3.95
A396	200	200	10	10	3.95
STEEL	HIGH TENSILE, ACCORDING TO BS 4482				

Client:
THE UNITED REPUBLIC OF TANZANIA
 DAWASA Chief Executive
 P. O. Box 1573
 Dunga/Malanga Street, Mwananyamala
 Dar es Salaam, Tanzania

Consultant:
DOHWA ENGINEERING CO., LTD
 In Association with
LUPTAN CONSULTANTS LIMITED
 and
 WWS Design & Development Co. Ltd
 DOHWA Engineering Co., Ltd
 LUPTAN CONSULTANTS Ltd

Project:
 Provision of Facilitation and Technical Services for Creation of Essential Framework Conditions, Capacity Building, Preparation of Detailed Engineering Designs and Bidding Documents, and Construction Supervision of the Off-grid Sanitation Works in Dar es salaam

Designed:	Drawn:	Title: SIMPLIFIED SEWER SYSTEM STANDARD DETAILS DRAWINGS INSPECTION CHAMBER 400mm x 400mm GENERAL ARRANGEMENT					
Checked:	Approved:						
Scale: NTS	Date: June, 2021						
Rev	Date	Description	Drawn	Check	Appr.	Rev. No: 01	Drawing No: SSS/MC/STD 303

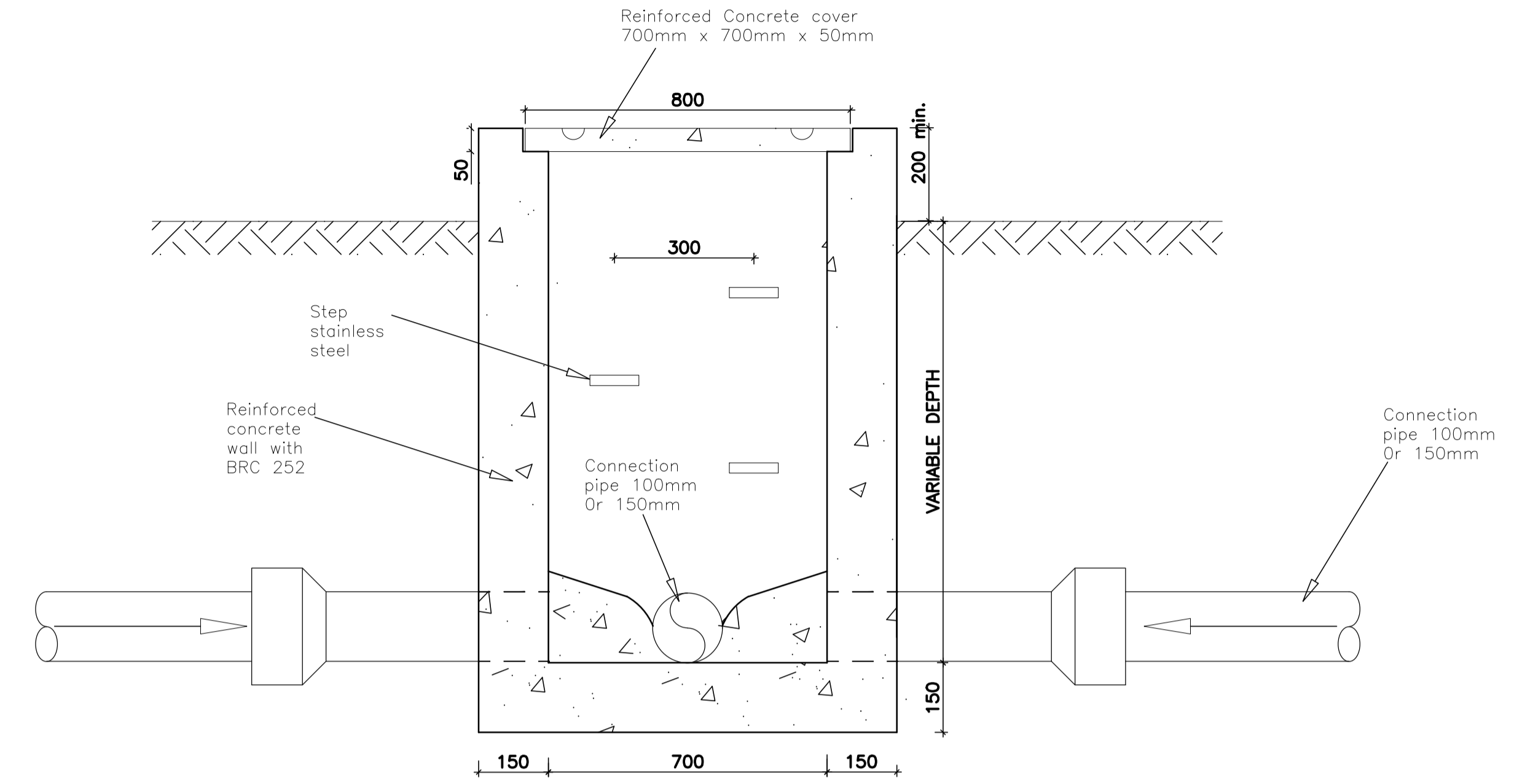
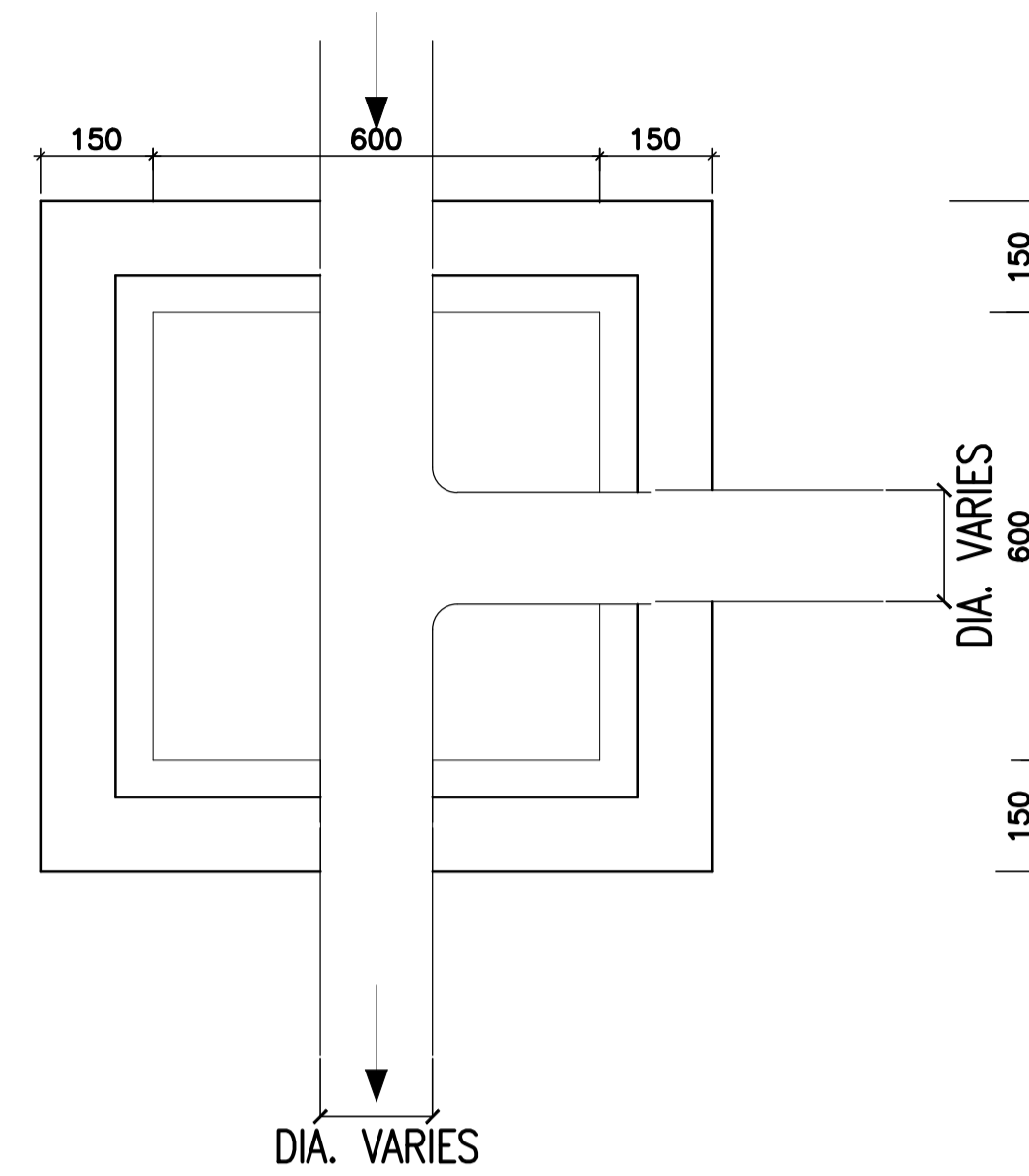
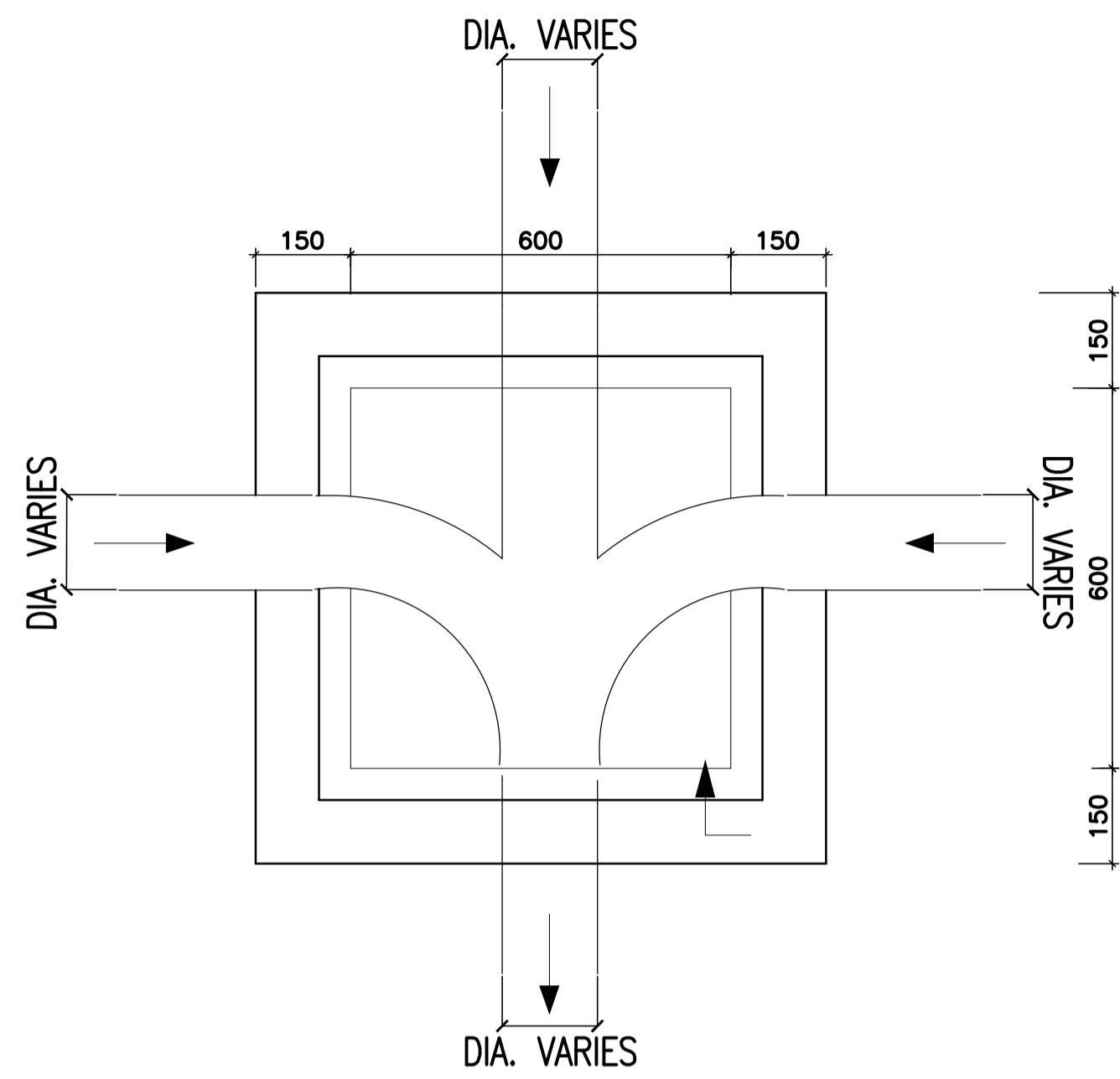

SECTION A-A

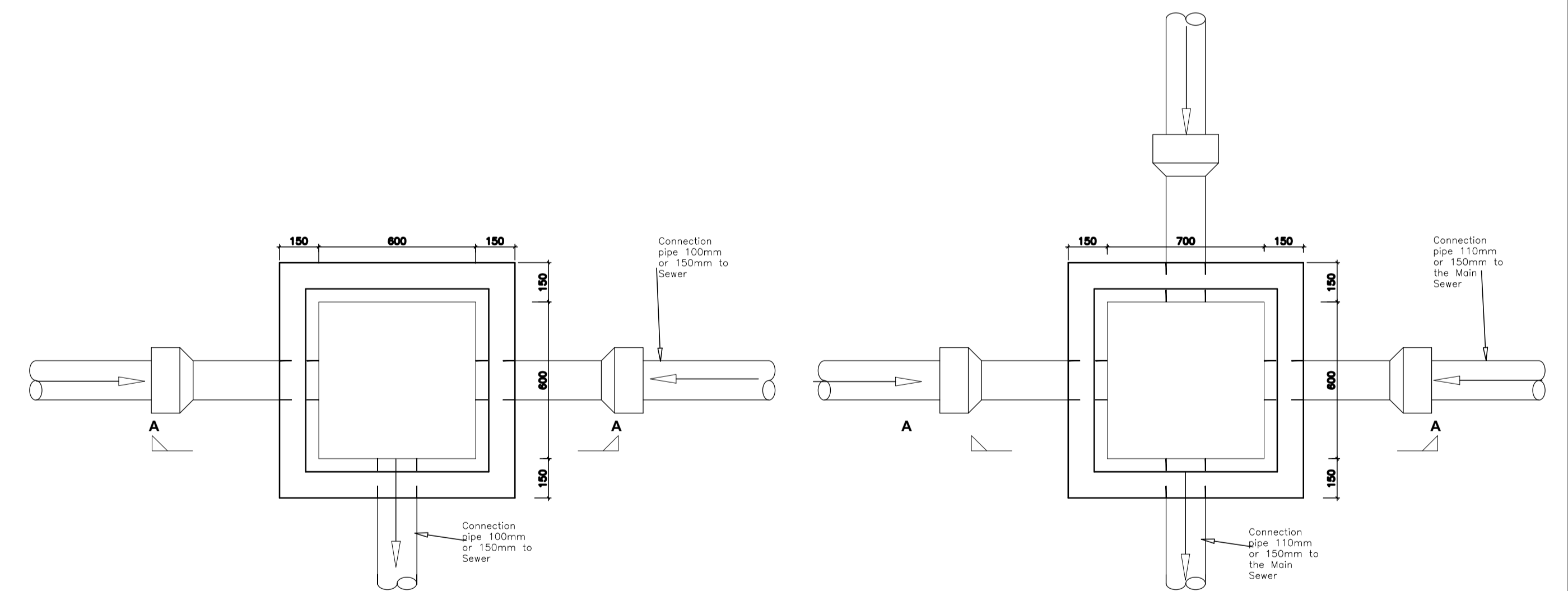
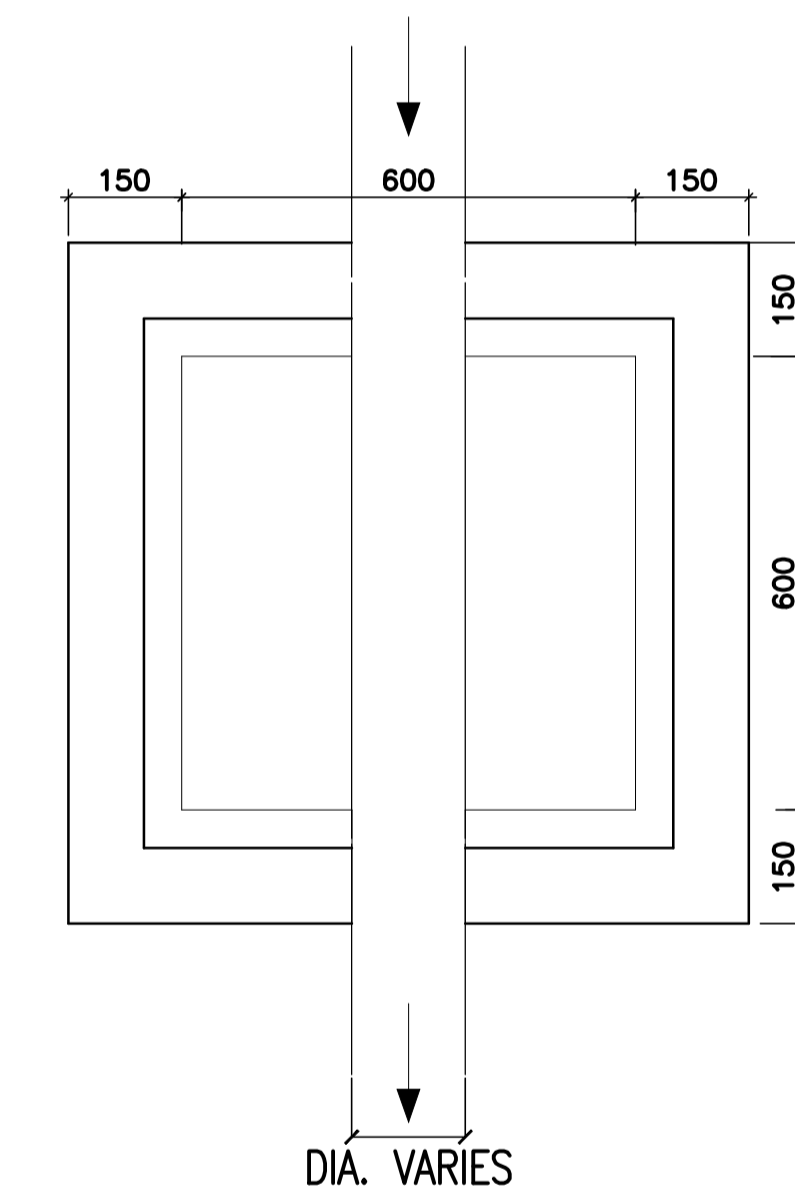
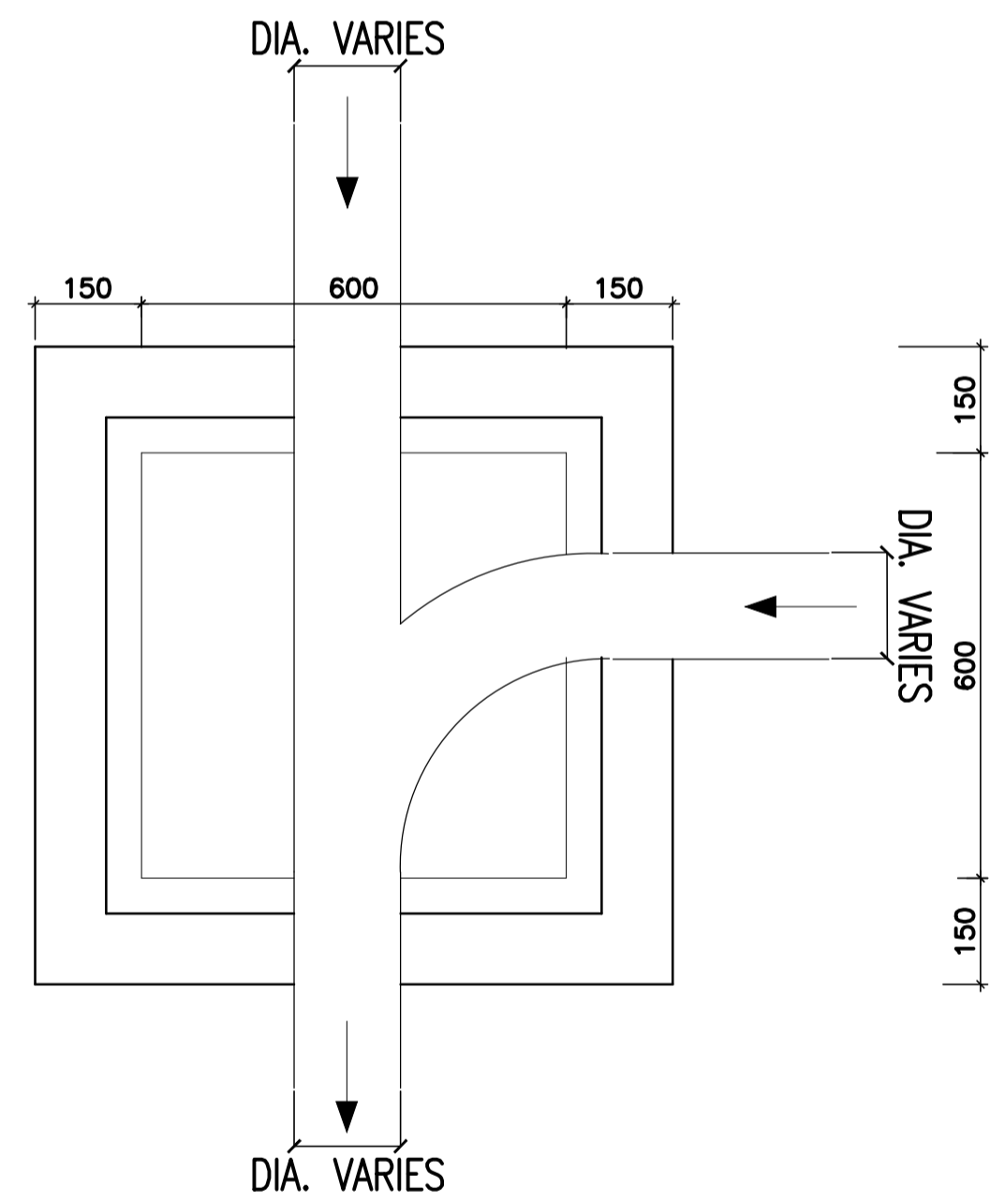

PLAN INSPECTION CHAMBER CONNECTIONS TYPE I

PLAN INSPECTION CHAMBER CONNECTIONS TYPE II

STANDARD MESH DETAILS FOR CONCRETE REINFORCEMENT

TYPE	WIRE SPACING		WIRE DIAMETER		WEIGHT/SQUARE METERS (kg/m ²)
	Main mm	Cross mm	Main mm	Cross mm	
A252	200	200	08	08	3.95
A396	200	200	10	10	3.95
STEEL	HIGH TENSILE, ACCORDING TO BS 4482				

Client:
THE UNITED REPUBLIC OF TANZANIA
 DAWASA Chief Executive
 P. O. Box 1573
 Dunga/Malanga Street, Mwananyamala
 Dar es Salaam, Tanzania

Consultant:
DOHWA ENGINEERING CO., LTD
 In Association with
LUPTAN CONSULTANTS LIMITED
 WWS Design & Development Co. Ltd
 and
 LUPTAN CONSULTANTS LTD

Project:
 Provision of Facilitation and Technical Services for Creation of Essential Framework Conditions, Capacity Building, Preparation of Detailed Engineering Designs and Bidding Documents, and Construction Supervision of the Off-grid Sanitation Works in Dar es salaam

Designed:	Drawn:	Title: SIMPLIFIED SEWER SYSTEM STANDARD DETAILS DRAWINGS				
Checked:	Approved:					
Scale: NTS	Date: June, 2021	Rev. No: 01				
Rev	Date	Description	Drawn	Check	Appr.	Drawing No: SSS/MC/STD 304



Front Elevation

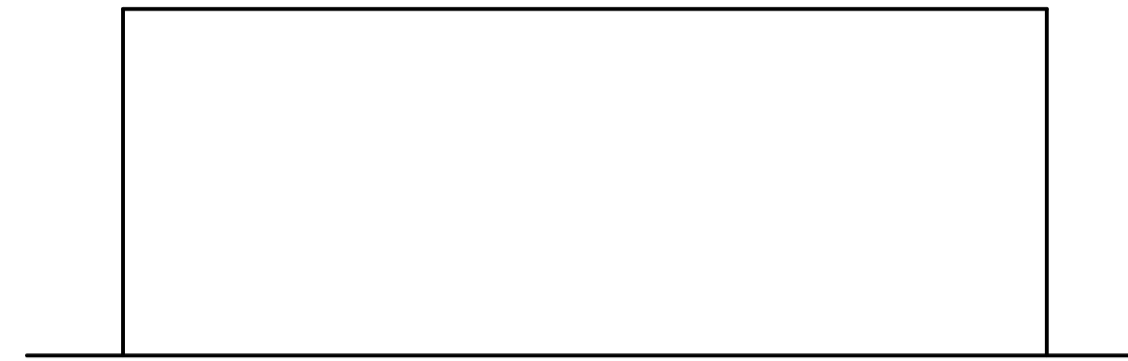

Rear Elevation

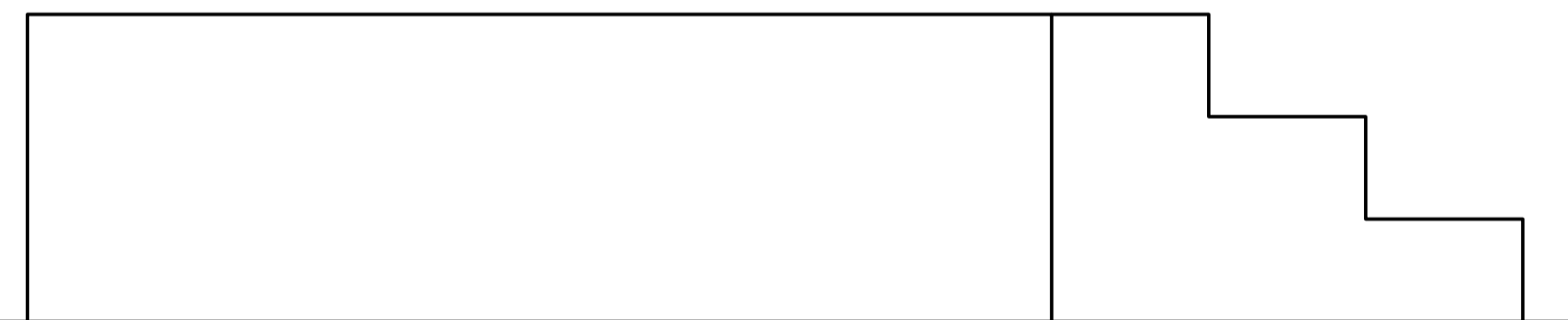

Right Side Elevation

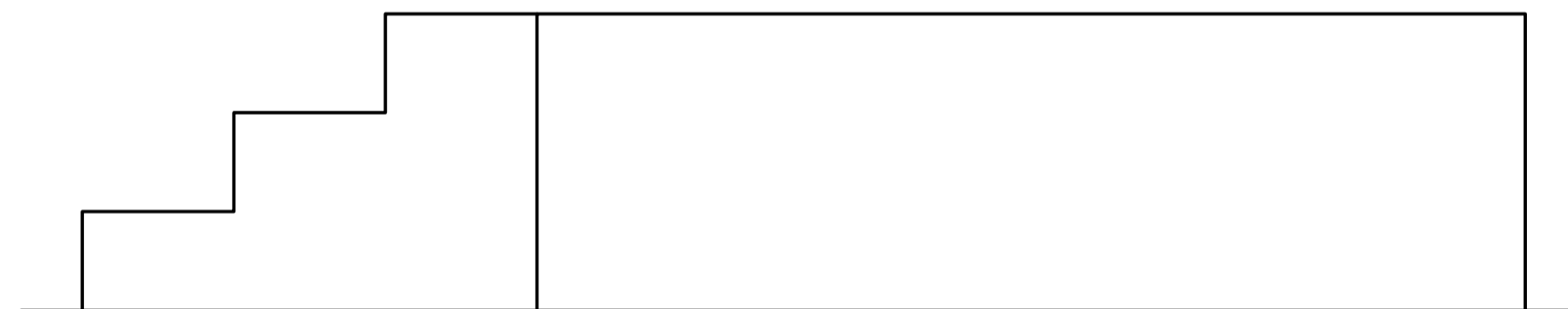

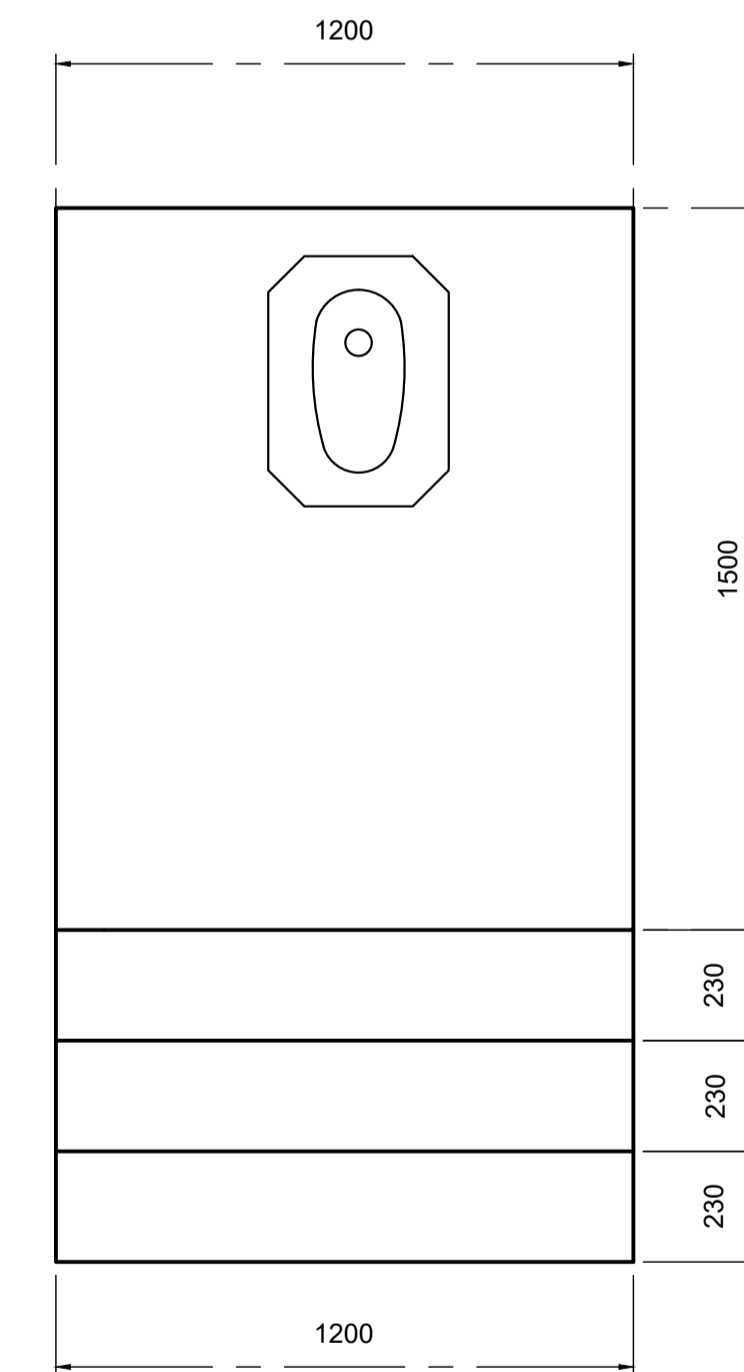

Left Side Elevation



FLOOR PLAN FOR TOILET

NOTES:

1. ALL DIMENSIONS ARE IN MILLIMETERS UNLESS OTHERWISE SHOWN
2. DO NOT SCALE FROM THIS DRAWING
3. THE SCALES GIVEN ON THIS DRAWING REFER TO THE A1 SIZE ORIGINAL DRAWING
4. THE SUBGRADE SHALL BE COMPACTED TO 99% MAXIMUM DRY DENSITY BEFORE THE PLACEMENT OF HARDCORE
5. CONCRETE SHALL BE CLASS C25 FOR STRUCTURAL MEMBERS AND CLASS C8/10 FOR BLINDING
6. THE MAXIMUM SIZE OF AGGREGATE SHALL BE 20mm UNLESS OTHERWISE SHOWN
7. REINFORCEMENT SHALL BE HIGH TENSILE DEFORMED TYPE WITH A CHARACTERISTIC YIELD STRESS OF AT LEAST 429N/mm²
8. COVER TO REINFORCEMENT SHALL BE:
 - FOUNDATIONS 50mm
 - SLABS 25mm
 - WALLS AND BEAMS 30mm
9. LAPS TO ALL REINFORCEMENT SHALL BE 50 * BAR DIAMETER UNLESS OTHERWISE SHOWN

Client:  THE UNITED REPUBLIC OF TANZANIA DAWASA Chief Executive P. O. Box 1573 Dunga/Malanga Street, Mwananyamala Dar es Salaam, Tanzania	Consultant:  DOHWA ENGINEERING CO., LTD In Association with  LUPTAN CONSULTANTS LIMITED ENGINEERING PLANNING MANAGEMENT CONSULTANTS and WWS Design & Development Co. Ltd	Project: Provision of Facilitation and Technical Services for Creation of Essential Framework Conditions, Capacity Building, Preparation of Detailed Engineering Designs and Bidding Documents, and Construction Supervision of the Off-grid Sanitation Works in Dar es salaam	Designed: Drawn: Checked: Approved: Scale: 1:16	Date: June, 2021	Title: SIMPLIFIED SEWER SYSTEM STANDARD DETAILS DRAWINGS DEMONSTRATION TOILET
			Rev Date Description Drawn Check Appr.	Rev. No: 01	Drawing No: SSS-STD-305-01

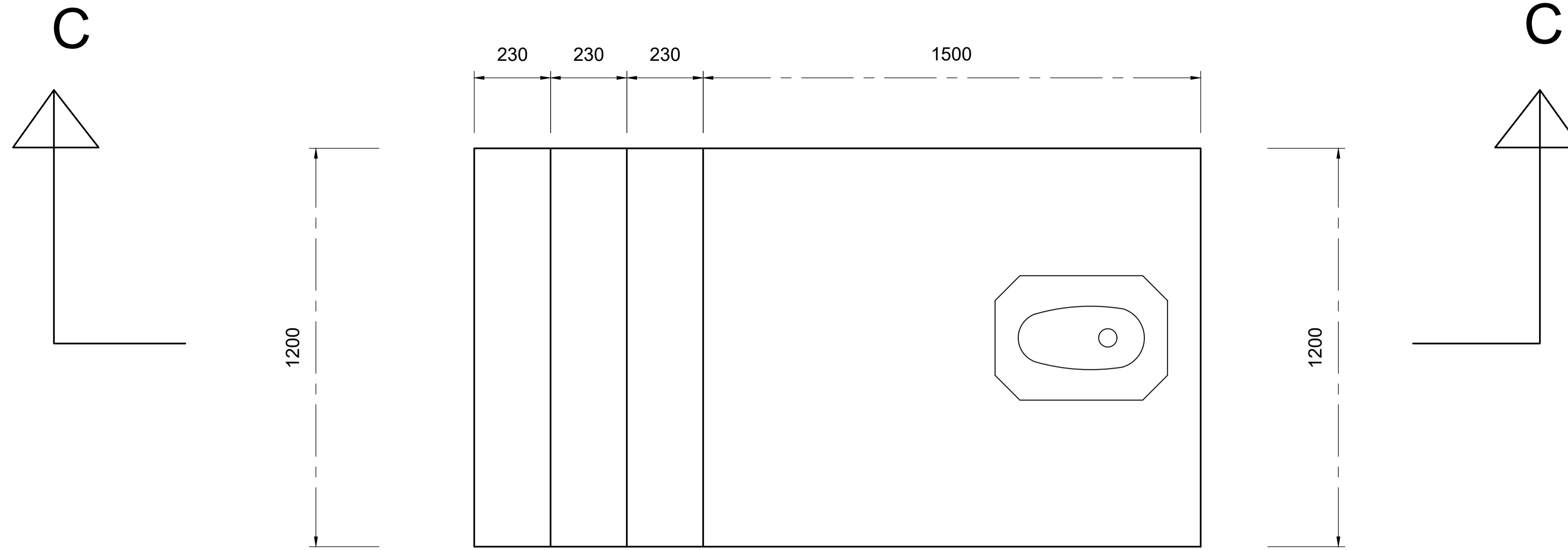

TOP PLAN
Scale 1:10

NOTES:

1. ALL DIMENSIONS ARE IN MILLIMETERS UNLESS OTHERWISE SHOWN
2. DO NOT SCALE FROM THIS DRAWING
3. THE SCALES GIVEN ON THIS DRAWING REFER TO THE A1 SIZE ORIGINAL DRAWING
4. THE SUBGRADE SHALL BE COMPACTED TO 99% MAXIMUM DRY DENSITY BEFORE THE PLACEMENT OF HARDCORE
5. CONCRETE SHALL BE CLASS C30/37 FOR STRUCTURAL MEMBERS AND CLASS C8/10 FOR BLINDING
6. THE MAXIMUM SIZE OF AGGREGATE SHALL BE 20mm UNLESS OTHERWISE SHOWN
7. REINFORCEMENT SHALL BE HIGH TENSILE DEFORMED TYPE WITH A CHARACTERISTIC YIELD STRESS OF AT LEAST 429N/mm²
8. COVER TO REINFORCEMENT SHALL BE:
 - FOUNDATIONS 50mm
 - SLABS 25mm
 - WALLS AND BEAMS 30mm
9. LAPS TO ALL REINFORCEMENT SHALL BE 50 * BAR DIAMETER UNLESS OTHERWISE SHOWN

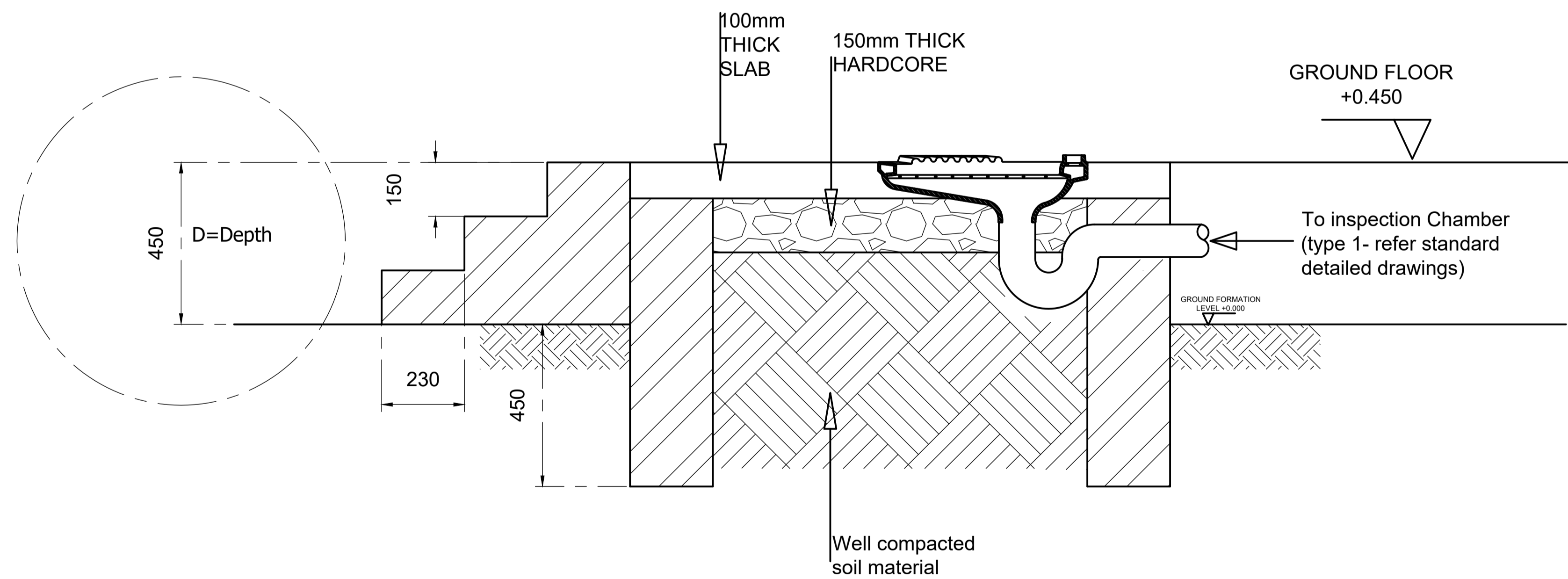

SECTION C-C
Scale 1:10

Client:

THE UNITED REPUBLIC OF TANZANIA
 DAWASA Chief Executive
 P. O. Box 1573
 Dunga/Malanga Street, Mwananyamala
 Dar es Salaam, Tanzania

Consultant:

DOHWA ENGINEERING CO., LTD
 In Association with  **LUPTAN CONSULTANTS LTD** and **WWS Design & Development Co. Ltd**
 DOHWA Engineering Co., Ltd
 LUPTAN Consults Ltd

Project:
 Provision of Facilitation and Technical Services for Creation of Essential Framework Conditions, Capacity Building, Preparation of Detailed Engineering Designs and Bidding Documents, and Construction Supervision of the Off-grid Sanitation Works in Dar es salaam

Designed:	Drawn:	Title:	
Checked:	Approved:	SIMPLIFIED SEWER SYSTEM STANDARD DETAILS DRAWINGS	
Scale:	Date:	DEMONSTRATION TOILET	
SHOWN	June, 2021	Rev. No:	Drawing No:
		01	SSS-STD-305-02
Rev	Date	Description	Drawn/Check/ Appr.

Appendix VII: Non-Technical Summary

THE UNITED REPUBLIC OF TANZANIA



MINISTRY OF WATER



Dar es Salaam Water Supply & Sanitation Authority

DAWASA Building, Dunga/Malaga Street, Mwananyamala Area
P. O. Box 1573, Dar es Salaam. TANZANIA.
Tel. +25522276006/15; Fax: +255222762480; E-mail:
dawasaceo@dawasa.co.tz

Provision of Consultancy Services for Preparation of Environmental and Social Impact Assessment (ESIA) and Resettlement Action Plan (RAP) Report for Construction of Off Grid Sanitation Projects

Ref No: TZ-DAWASA-91652-CS-QCBS

Comprehensive Project Brief for the Proposed Simplified Sewerage System to be constructed at Kombo Mtaa, Vingunguti Ward, Ilala District, Dar es Salaam Region

NON-TECHNICAL EXECUTIVE SUMMARY
(English and Kiswahili Versions)

Submitted to:

National Environment Management Council,

Head Office, Kambarage Tower, 6th Floor, P. O. Box 2724, Dodoma.

Phone: +255 262960098, 0713608930,

Email Address: nemcdg@nemc.or.tz

Website: www.nemc.or.tz

Lead Consultant:

Prof. Rubhera RAM Mato (PhD), CEng. (T), Reg. EIA Expert
Mobile: +255754898592; E-Mail: rubheramato@gmail.com

29th November 2022

NON-TECHNICAL EXECUTIVE SUMMARY

Comprehensive Project Brief for the Proposed Simplified Sewerage System to be constructed at Kombo Mtaa, Vingunguti Ward, Ilala District, Dar es Salaam Region

Proponent: DAWASA

Proponent's Contact: DAWASA House, **Dunga/Malanga**

Street/Mwananyamala

P.O Box 1573 DSM

Tel: +255222760006/15

Fax: +255222762480

Email Address: info@dawasa.go.tz

EIA Expert:

Prof. Rubhera RAM Mato

(PhD), CEng. (T), Reg. EIA Expert

Mobile: +255754898592

E-Mail: rubheramato@gmail.com

INTRODUCTION

The Government of the United Republic of Tanzania (GoT) through the Dar es Salaam Water and Sewerage Authority (DAWASA) under the Ministry of Water intends to implement an Off-Grid Sanitation Project (OGSP) in Dar es Salaam City to serve peri-urban areas not connected to the central sewerage system. DAWASA has received financing from the International Development Association (IDA) in the form of a credit to implement the project. Before implementing the project, the law in Tanzania requires an Environmental Impact Assessment to be conducted and approved by the relevant authority. To comply with the law in Tanzania, the DAWASA intends to apply a portion of the proceeds of the credit to eligible payments for consulting services for Preparation of Environmental and Social Impact Assessment (ESIA) and Resettlement Action Plan (RAP) Report for the construction of off-grid sanitation projects.

Dar es Salaam is the largest and most important commercial and industrial center in Tanzania. The city has an estimated population of about 5.0 million

and is projected to double at the end of the project horizon of 25 years. About 10% of the population is served by sewers and the rest almost depend on on-site sanitation systems. The sewer coverage is only limited to the area within the city center with a total length of 67.8km and the system is based on a separate system and discharges their effluent into oxidation ponds, and into the sea through a sea outfall of about 1.03km long. The onsite sanitation systems result in Faecal sludge of which handling and management throughout the sanitation chain (from domestic containment, transportation as well as disposal and treatment) is currently hygienically inadequate thus posing environmental and public health risks. The Off-Grid project is intended to address these challenges. The Off-Grid project is divided into several subprojects which will be implemented in the five municipalities of Dar es Salaam City. One of these is the Construction of Simplified Sewerage System at Kombo Mtaa, in Vingunguti Ward, Ilala District. The project is planned to connect 570 households with an estimated population of 25,600 people.

This study was conducted following the Environmental Management (Environmental Impact Assessment and Audit) (Amendment) Regulations, 2018 along with the Environmental Impact Assessment and Audit Regulations of 2005. These Regulations provide legal procedures for implementing the requirements of the Environmental Management Act Cap.191 of 2004. The Regulations give a mandate to NEMC to oversee the EIA process, which culminates with an award of the EIA Certificate by the Ministry responsible for Environment.

Following the EIA Regulations, NEMC is mandated to screen projects and make decisions of the level of EIA required as well as evaluating the adequacy of respective environmental statements. Considering the nature and size of the proposed “Simplified Sewerage System in Ilala Municipality”, the project falls under Category “B2” (Non-Mandatory) following Reg.4 (1)(c) and First Schedule of the amended 2018 Regulations which categorizes the *night soil collection and treatment* being under the ‘*List of small-scale activities and enterprises that require registration but shall not require Environmental Impact*

Assessment. Further, the projects shall not require screening and scoping, rather, the Project Brief shall be examined and issued with an Environmental Impact Assessment Certificate'. The regulations require developers to prepare and submit to the National Management Council (NEMC) filled EIA registration forms and "Project Briefs" for all B2 projects. The preparation and content of the "Project Briefs" are provided under Reg.6 (1). The same has been followed in preparing this "Project Brief". The study for preparing this project brief was conducted from July to October 2020.

This project brief for the Proposed Construction of Simplified Sewerage System in Ilala Municipality is being submitted to NEMC together with EIA Registration Forms for EIA Certificate decision.

PROJECT DESCRIPTION

Vingunguti is an administrative ward situated at -6.840225 Longitude, 39.23411 Latitude in Ilala District of Dar-es-salaam Region. The ward that is located in the southwest of Dar-es-salaam, comprises of six streets that is Mtambani, Mtakuja, Miembeni, Kombo, Butiama and Majengo. The streets are unplanned settlement with restricted access roads for faecal sludge emptying trucks. Furthermore, the ward is characterized by having underlying geographical formation setback where water table is significantly high.

Currently, this area is being served through on-site sanitation management that involves domestic containment and emptying trucks that are not satisfactorily managed.

The project area is accessible through Nkurumah street then Julius Nyerere road all the way to Nelson Mandela junction finally unto Mandela road at Sheli bus stop 8.4 Kilometers.

The proposed project intends to use the existing alleys (*vichocho*) for installing the simplified sewer pipelines. The local government in the project area has agreed with DAWASA through a formal meeting held on 09/07/2020 to use the alleys whether formal or non-formal for the construction of a simplified

sewerage system and the associated appurtenances to improve the sanitation conditions.

POLICIES, LEGISLATION AND INSTITUTIONAL ARRANGEMENTS

Sector policies that were reviewed when executing the proposed development are;

- National Environment Policy 2021
- National Land Policy of 1997
- Construction Industry Policy (2003)
- National Health Policy (2003)
- National Gender Policy of 2000
- National Human Settlements Development Policy (2000)

Principal Acts, regulations and guidance that support and provide guidelines to implement the intended project are;

- Environmental Management Act (2004)
- The Environmental Management (Fees and Charges) Regulations, 2021
- The Environmental Management (Control of hazardous Waste) regulations, 2021
- The Environmental Management (Control of Noise and vibration) regulations, 2015
- The Environmental Management (Prohibition of Plastic Carrier bags) regulations, 2019
- The Environmental Management (Solid Waste Management) regulations, 2007
- The Environmental Management (Water Quality) regulations, 2009
- The Environmental Management (Air Quality) regulations, 2009
- The Environmental Management (Soil Quality) regulations, 2009
- Occupational Health and Safety Act 2003
- The Water Supply and Sanitation Act No. 12 of 2009

- Engineers Registration Act and its Amendments 1997 and 2007
- The Contractors Registration (Amendment) Act, 2008
- The Architects and Quantity Surveyors Act (1997)
- The Urb World Bank guidelines for Environmental Managementan Planning Act (2007)
- Public Health Act (2009)

STAKEHOLDERS ISSUES AND CONCERNS

Different stakeholders were consulted. Among of the issues that arise during consultation at the Ilala Municipal Council and community at Kombo Mtaa are:

Facilities to be developed

- Proper awareness to people on best ways to dispose pads and other waste in order to avoid system blockage
- The proposed facilities should be well protected

Awareness to the community

- Awareness to the people on the system operation, since it is a new technology
- Awareness to the community to avoid riots in the future
- Educate the community to avoid the use of detrimental disinfectants to the system so as to avoid system failure and contaminated manures.

PROJECT REQUIREMENTS AND WASTE GENERATION

Project requirements

The main materials for construction of Simplified sewerage system include cement, aggregates (stones), water, steel, sand, timbers, blocks, PVC pipes, and gravels. During the construction phase the project will require not less than 100 workers both skilled and non-skilled laborers for each

phase of project construction. During operational phase it is estimated that 30 unskilled workers will be retained for operating the system.

Equipment expected to be used during the construction works are Tippers, Concrete Mixers, poker vibrators, Wheel barrow, Compactor, etc.

Wastes generation

The major wastes generation associated with the project are solid wastes and liquid waste. During the maximum operation phase a total of 100m³ per day of liquid waste is estimated to be received at the downstream receiving chamber of the Fecal sludge treatment facility close to the project site. During construction it is expected that at least 60kg of solid wastes will be produced.

POTENTIAL IMPACTS

The following impacts were identified to be likely to occur during mobilization phase:

- Employment opportunities
- Noise pollution
- Air pollution from dust emission
- Blockage of paths

The following impacts were identified to be likely to occur during the construction phase;

- Employment opportunities
- Increased socio-cultural interaction
- Increased Revenue to the nation through taxes, both direct and indirect
- Cost reduction for sewage management
- Increased HIV/AIDS and other sexual related diseases
- Land degradation and increased erosion
- Noise pollution
- Air Pollution from dust emission
- High Risk of Health associated with construction work

- Waste generation during construction
- Sewer leakage/overflow
- Blockage of paths

The following impacts were identified to be likely to occur during the operational phase;

- Improved social-economic livelihood and dignity within the beneficiary society
- Increased Revenue to the nation through taxes, both direct and indirect
- Cost reduction for sewage management
- Sewer leakage/overflow

MITIGATION MEASURES AND ENVIRONMENTAL AND SOCIAL MANAGEMENT PLAN (ESMP)

The options to minimize or prevent the identified adverse social and environmental impacts as well as a monitoring plan have been suggested in this report and are contained in the ESMP. Many of them are based on good engineering practices and the timely responsiveness of the responsible institution. The ESMP describes the implementation schedule of the proposed mitigation measures as well as planning for long-term monitoring activities. It defines the roles and responsibilities of different actors of the plan. The Approach environmental and social costs amount to Tshs 38,000,000.00. The estimated annual costs for carrying out the proposed environmental and social motoring program amounts to TSH 28,000,000.00.

DECOMMISSIONING PLAN

The decommissioning is not anticipated in the foreseeable future. However, if this will happen, may entail change of use (functional changes) or demolition triggered by change of land use. In view of this, specific mitigation measures pertaining to environmental impacts of decommissioning works cannot be proposed at the moment with a reasonable degree of certainty.

CONCLUSION

The proposed project is of greater profit to the community and the country at large as it promotes and improve sanitation in the streets. When there is good and improved sanitation, then the outbreak of diseases like diarrhoea and associated stomach and waterborne diseases are also reduced and prevented hence improved public health.

The impacts identified are preventable and of less negativity to the community, therefore the developer can be provided with the environmental clearance certificate in order to commence the implementation of the project.

It is, therefore, concluded that implementation of the proposed construction of the Simplified sewerage system at Kombo Mtaa will entail no detrimental impacts provided that the recommended mitigation measures are adequately and timely put in place. The identified adverse impacts shall be managed through the proposed mitigation measures and implementation regime laid down in this EIS. DAWASA is committed to implementing all the recommendations given in the EIS and further carrying out the environmental auditing and monitoring schedules.

MUHTASARI USIO WA KIUFUNDI
Muhtasari wa Mradi wa Mapendekezo ya Mfumo Rahisi wa Majitaka
unaokusudiwa kujengwa katika Mtaa wa Kombo, Kata ya Vingunguti,
Wilaya ya Ilala, Mkoa wa Dar es Salaam.

Mmiliki: Mamlaka ya Majisafi na Usafi wa Mazingira Dar es Salaam

Mawasiliano ya Mmiliki: DAWASA,

DAWASA Building, Dunga/Malaga Street,
Mwananyamala

S.L.P 1573, Dar es Salaam. TANZANIA.

Simu. +25522276006/15; Fax: +255222762480;

Barua Pepe: dawasaceo@dawasa.co.tz

Mshauri Mwelekezi: Prof. Rubhera RAM Mato (PhD), CEng. (T), Reg. EIA Expert
S.L.P 35478, Dar es Salaam, Tanzania

Simu: +255754898592

Barua Pepe: rubheramato@gmail.com

UTANGULIZI

SERIKALI ya Jamhuri ya Muungano wa Tanzania (GoT) kupitia Mamlaka ya Majisafi na Majitaka Dar es Salaam (DAWASA) chini ya Wizara ya Maji inatarajia kutekeleza Mradi wa Usafi wa Mazingira Nje ya Mtandao (OGSP) katika Jiji la Dar es Salaam ili kuhudumia maeneo ya pembezoni mwa miji. maeneo ambayo hayajaunganishwa na mfumo mkuu wa maji taka. DAWASA imepata ufadhili kutoka kwa Jumuiya ya Maendeleo ya Kimataifa (IDA) ikiwa ni mkopo wa kutekeleza mradi huo. Kabla ya kutekeleza mradi huo, sheria nchini Tanzania inataka Tathmini ya Athari kwa Mazingira ifanyike na kuidhinishwa na mamlaka husika. Ili kuzingatia sheria nchini Tanzania, DAWASA inatarajia kutumia sehemu ya mapato ya mikopo kwa malipo stahiki kwa ajili ya huduma za ushauri kwa ajili ya Maandalizi ya Tathmini ya Athari kwa Mazingira na Kijamii (ESIA) na Ripoti ya Mpango Kazi wa Makazi mapya (RAP) kwa ajili ya ujenzi wa miradi ya usafi wa mazingira nje ya gridi ya taifa.

Dar es Salaam ni kituo kikubwa na muhimu zaidi cha biashara na viwanda nchini Tanzania. Jiji lina idadi ya watu wanaokadiriwa kuwa milioni 5.0 na inakadiriwa kuongezeka mara mbili mwishoni mwa upeo wa mradi wa miaka 25. Takriban 10% ya watu wanahudumiwa na mifereji ya maji machafu na

wengine karibu hutegemea mifumo ya usafi wa mazingira kwenye tovuti. Mfereji wa maji taka ni mdogo tu kwa eneo la katikati mwa jiji lenye urefu wa jumla ya 67.8km na mfumo unategemea mfumo tofauti na humwaga maji machafu yao kwenye madimbwi ya vioksidishaji, na baharini kupitia mkondo wa bahari wa takriban kilometa 1.03. Mifumo ya usafi wa mazingira kwenye tovuti husababisha uchafu wa kinyesi ambao utunzaji na usimamizi wake katika mnyororo mzima wa usafi wa mazingira (kutoka kwa vyombo vya nyumbani, usafirishaji na utupaji na matibabu) kwa sasa hautoshi kiafya na hivyo kuhatarisha mazingira na afya ya umma. Mradi wa Off-Grid unakusudiwa kutatua changamoto hizi. Mradi wa Off-Grid umegawanywa katika miradi midogo kadhaa ambayo itatekelezwa katika manispaa tano za Jiji la Dar es Salaam. Mojawapo ni Ujenzi wa Mfumo wa Majitaka Rahisi katika Mtaa wa Kombo, Kata ya Vingunguti, Wilaya ya Ilala. Mradi umepangwa kuunganisha kaya 570 zenye idadi ya watu wanaokadiriwa kuwa 25,600.

Utafiti huu ulifanyika kwa kufuata Kanuni za Usimamizi wa Mazingira (Tathmini na Ukaguzi wa Athari kwa Mazingira) (Marekebisho), 2018 pamoja na Tathmini ya Athari za Mazingira na Kanuni za Ukaguzi za mwaka 2005. Kanuni hizi zinatoa taratibu za kisheria za kutekeleza matakwa ya Sheria ya Usimamizi wa Mazingira Sura ya 191. ya 2004. Kanuni zinatoa mamlaka kwa NEMC kusimamia mchakato wa EIA, ambao unaishia kwa kutunukiwa Cheti cha EIA na Wizara inayohusika na Mazingira.

Kufuatia Kanuni za EIA, NEMC ina mamlaka ya kuchunguza miradi na kufanya maamuzi ya kiwango cha EIA kinachohitajika pamoja na kutathmini utoshelevu wa taarifa za mazingira husika. Kwa kuzingatia aina na ukubwa wa pendekezo la "Mfumo wa Maji taka uliorahisishwa katika Manispaa ya Ilala", mradi uko chini ya Kitengo "B2" (Si cha Lazima) kinachofuata Kanuni ya 4 (1)(c) na Jedwali la Kwanza la Kanuni zilizorekebisha za 2018 ambazo zinaainisha. ukusanyaji na matibabu ya udongo usiku ukiwa chini ya 'Orodha ya shughuli ndogo ndogo na biashara zinazohitaji usajili lakini hazitahitaji Tathmini ya Athari kwa Mazingira. Zaidi ya hayo, miradi haitahitaji uchunguzi na upeo, badala yake, Muhtasari wa Mradi utachunguzwa na kutolewa kwa Cheti cha Tathmini ya

Athari kwa Mazingira, TAM. Kanuni hizo zinawataka wasanidi programu kuandaa na kuwasilisha kwa Baraza la Kitaifa la Usimamizi (NEMC) lililojaza fomu za usajili wa EIA na "Muhtasari wa Miradi" kwa miradi yote ya B2. Maandalizi na maudhui ya "Muhtasari wa Mradi" yametolewa chini ya Reg.6 (1). Vile vile vimefuatwa katika kuandaa "Muhtasari wa Mradi". Utafiti wa kuandaa muhtasari wa mradi huu ulifanyika Julai hadi Oktoba 2020.

Muhtasari huu wa mradi wa Mapendekezo ya Ujenzi wa Mifumo ya Majitaka iliyorahisishwa katika Manispaa ya Ilala unawasilishwa NEMC pamoja na Fomu za Usajili wa TAM kwa uamuzi wa Cheti cha TAM.

MAELEZO YA MRADI

Vingunguti ni kata ya Wilaya ya Ilala katika Mkoa wa Dar-es-salaam yenye namba -6.840225 Longitudo,39.23411 Kata hiyo ambayo ipo kusini magharibi mwa jiji la Dar-es-salaam, ina mitaa sita ambayo ni Mtambani, Mtakuja, Miembeni, Kombo, Butiama na Majengo. Mitaa ni makazi ambayo hayajapangwa na barabara zenye vizuizi vya kuingia kwa lori za kumwaga uchafu. Zaidi ya hayo, kata ina sifa ya kuwa na upungufu wa malezi ya kijiografia ambapo kiwango cha maji kiko juu sana.

Kwa sasa, eneo hili linahudumiwa kupitia usimamizi wa usafi wa mazingira kwenye tovuti ambao unahusisha uzuiaji wa magari ya ndani na kuondoa mizigo ambayo haidhibitiwi ipasavyo.

Eneo la mradi linafikika kupitia mtaa wa Nkurumah kisha Julius Nyerere hadi makutano ya Nelson Mandela hatimaye hadi barabara ya Mandela kwenye kituo cha mabasi cha Sheli Kilomita 8.4.

Mradi unaopendekezwa unakusudia kutumia vichocho vilivyopo (vichocho) kwa ajili ya kuweka mabomba ya maji taka yaliyorahisishwa. Serikali ya mtaa katika eneo la mradi imekubaliana na DAWASA kupitia kikao rasmi kilichofanyika tarehe 09/07/2020 kutumia vichocho iwe rasmi au visivyo rasmi kwa ajili ya ujenzi wa mfumo wa majitaka uliorahisishwa na vyombo vinavyohusika ili kuboresha mazingira ya usafi.

SERA, SHERIA NA MIPANGO YA TAASISI

Sera za kisekta ambazo zilipitiwa upya wakati wa utekelezaji wa maendeleo yaliyopendekezwa ni;

- Sera ya Kitaifa ya Mazingira ya 2021
- Sera ya Taifa ya Ardhi ya mwaka 1997
- Sera ya Sekta ya Ujenzi (2003)
- Sera ya Taifa ya Afya (2003)
- Sera ya Taifa ya Jinsia ya 2000
- Sera ya Taifa ya Maendeleo ya Makazi (2000)

Sheria Kuu, kanuni na miongozo inayosaidia na kutoa miongozo ya kutekeleza mradi uliokusudiwa ni;

- Sheria ya Usimamizi wa Mazingira (2004)
- Kanuni za Usimamizi wa Mazingira (Ada na Ada) za 2021
- Kanuni za Usimamizi wa Mazingira (Udhibiti wa Taka hatarishi), 2021
- Kanuni za Usimamizi wa Mazingira (Udhibiti wa Kelele na Mtetemo), 2015
- Kanuni za Usimamizi wa Mazingira (Marufuku ya Mifuko ya Kubeba Plastiki), za 2019
- Kanuni za Usimamizi wa Mazingira (Udhibiti wa Taka Ngumu), 2007
- Kanuni za Usimamizi wa Mazingira (Ubora wa Maji), 2009
- Kanuni za Usimamizi wa Mazingira (Ubora wa Hewa), 2009
- Kanuni za Usimamizi wa Mazingira (Ubora wa Udongo), 2009
- Sheria ya Afya na Usalama Kazini ya 2003
- Sheria ya Ugavi wa Maji na Usafi wa Mazingira Na. 12 ya 2009
- Sheria ya Usajili wa Wahandisi na Marekebisho yake ya 1997 na 2007
- Sheria ya Usajili wa Makandarasi (Marekebisho) ya mwaka 2008
- Sheria ya Wabunifu na Wakadiriaji Majenzi (1997)
- Miongozo ya Benki ya Dunia ya Urb kwa Sheria ya Mipango ya Usimamizi wa Mazingira (2007)
- Sheria ya Afya ya Umma (2009)

MASUALA NA MAMBO YA WADAU

Wadau mbalimbali walishauriwa. Miongoni mwa mambo yanayojitokeza wakati wa mashauriano katika Halmashauri ya Manispaa ya Ilala na jamii katika Mtaa wa Kombo ni pamoja na:

Vifaa vya kuendelezwa

- Uelewa sahihi kwa watu juu ya njia bora za kutupa pedi na taka zingine ili kuzuia kuziba kwa mfumo
- Vifaa vinavyopendekezwa vinapaswa kulindwa vyema
- Ufahamu kwa jamii
- Ufahamu kwa watu juu ya uendeshaji wa mfumo, kwa kuwa ni teknolojia mpya
- Uhamasishaji kwa jamii kuepuka machafuko siku zijazo
- Kuelimisha jamii kuepuka matumizi ya dawa hatarishi kwenye mfumo ili kuepusha kushindwa kwa mfumo na mbolea iliyochafuliwa.

MAHITAJI YA MRADI NA UZALISHAJI WA TAKA

Mahitaji ya mradi

Nyenzo kuu za ujenzi wa mfumo wa maji taka uliorahisishwa ni pamoja na saruji, mikusanyiko (mawe), maji, chuma, mchanga, mbao, vitalu, mabomba ya PVC na changarawe. Wakati wa awamu ya ujenzi mradi utahitaji wafanyakazi wasiopungua 100 wenye ujuzi na vibarua wasio na ujuzi kwa kila awamu ya ujenzi wa mradi. Wakati wa awamu ya uendeshaji inakadiriwa kuwa wafanyakazi 30 wasio na ujuzi watahifadhiwa kwa uendeshaji wa mfumo.

Vifaa vinavyotarajiwa kutumika wakati wa kazi za ujenzi ni Tippers, Mixers Zege, vibrators poker, barrow gurudumu, Compactor, nk.

Uzalishaji wa taka

Uzalishaji mkubwa wa taka unaohusishwa na mradi ni taka ngumu na taka za kioevu. Wakati wa awamu ya upeo wa operesheni jumla ya 100m³ kwa siku ya taka ya kioevu inakadiriwa kupokelewa kwenye chumba cha kupokelea cha

chini cha mkondo cha kituo cha kutibu kinyesi karibu na eneo la mradi. Wakati wa ujenzi inatarajiwa kwamba angalau 60kg ya taka ngumu itatolewa.

ATHARI ZINAZOWEZA

Athari zifuatazo zilitambuliwa kuwa zinaweza kutokea wakati wa awamu ya uhamasishaji:

- Fursa za ajira
- Uchafuzi wa kelele
- Uchafuzi wa hewa kutokana na uchafuzi wa vumbi
- Kuziba kwa njia

Athari zifuatazo zilitambuliwa kuwa zinaweza kutokea wakati wa awamu ya ujenzi;

- Fursa za ajira
- Kuongezeka kwa mwingiliano wa kijamii na kitamaduni
- Ongezeko la Mapato kwa taifa kupitia kodi, za moja kwa moja na zisizo za moja kwa moja
- Kupunguza gharama za usimamizi wa maji taka
- Kuongezeka kwa VVU/UKIMWI na magonjwa mengine yanayohusiana na ngono
- Uharibifu wa ardhi na kuongezeka kwa mmomonyoko wa ardhi
- Uchafuzi wa kelele
- Uchafuzi wa Hewa kutokana na uchafuzi wa vumbi
- Hatari kubwa ya Afya inayohusishwa na kazi ya ujenzi
- Uzalishaji wa taka wakati wa ujenzi
- Kuvuja kwa maji taka/kufurika
- Kuziba kwa njia

Athari zifuatazo zilitambuliwa kuwa zinaweza kutokea wakati wa awamu ya uendeshaji;

- Kuboresha maisha ya kijamii na kiuchumi na heshima ndani ya jamii inayofaidika
-

- Ongezeko la Mapato kwa taifa kupitia kodi, za moja kwa moja na zisizo za moja kwa moja
- Kupunguza gharama za usimamizi wa maji taka
- Kuvuja kwa maji taka/kufurika

HATUA ZA KUPUNGUZA NA MPANGO WA USIMAMIZI WA MAZINGIRA NA KIJAMII (ESMP)

Chaguzi za kupunguza au kuzuia athari mbaya za kijamii na kimazingira zilizotambuliwa pamoja na mpango wa ufuatiliaji zimependekezwa katika ripoti hii na zimo katika ESMP. Wengi wao ni msingi wa mazoea mazuri ya uhandisi na mwitikio wa wakati wa taasisi inayowajibika. ESMP inaelezea ratiba ya utekelezaji wa mapendekezo ya hatua za kupunguza na pia kupanga shughuli za ufuatiliaji wa muda mrefu. Inafafanua majukumu na wajibu wa watendaji mbalimbali wa mpango. Gharama za Mbinu za kimazingira na kijamii zinafikia Tshs 38,000,000.00. Makadirio ya gharama za kila mwaka za kutekeleza mpango unaopendekezwa wa magari ya kimazingira na kijamii ni TSH 28,000,000.00.

MPANGO WA KUONDOKA

Uondoaji wa amri hautarajiwi katika siku zijazo zinazoonekana. Hata hivyo, kama hii itatokea, inaweza kuhusisha mabadiliko ya matumizi (mabadiliko ya kiutendaji) au uharibifu unaosababishwa na mabadiliko ya matumizi ya ardhi. Kwa kuzingatia hili, hatua mahususi za kupunguza zinazohusu athari za kimazingira za kazi za uondoaji kazi haziwezi kupendekezwa kwa sasa kwa kiwango cha uhakika.

HITIMISHO

Mradi unaopendekezwa una faida kubwa kwa jamii na nchi kwa ujumla kwani unakuza na kuboresha usafi wa mazingira mitaani. Kunapokuwa na usafi wa mazingira bora na ulioboreshwa, basi mlipuko wa magonjwa kama vile kuhara na magonjwa yanayohusiana na tumbo na yale yatokanayo na maji pia hupungua na kuzuiwa hivyo kuboreshwa kwa afya ya umma.

Athari zilizoainishwa zinaweza kuzuilika na hazina hasi kidogo kwa jamii, kwa hivyo msanidi anaweza kupewa cheti cha kibali cha mazingira ili kuanza kuhusisha mradi.

Hivyo basi, inahitimishwa kuwa utekelezaji wa mapendekezo ya ujenzi wa mfumo wa majitaka uliorahisishwa katika Mtaa wa Kombo hautaleta madhara yoyote isipokuwa kwamba hatua zinazopendekezwa za kupunguza madhara zimewekwa ipasavyo na kwa wakati. Athari mbaya zilizotambuliwa zitadhibitiwa kupitia hatua zilizopendekezwa za kupunguza na mfumo wa utekelezaji uliowekwa katika ripoti ya TAM. DAWASA imejitolea kutekeleza mapendekezo yote yaliyotolewa katika ripoti ya TAM na kutekeleza zaidi ratiba za ukaguzi na ufuatiliaji wa mazingira.